

# User Manual

---

---

## TVX-PVR M-6640



- ◆ TVX-HD M-6600A – optional DVB-T dual tuner
- ◆ TVX-HD M-6600N – Memory Card Reader + Internal Wifi + optional DVB-T tuner
- ◆ TVX PVR M-6620N – Memory Card Reader + Internal Wifi + ATSC Dual digital TV
- ◆ TVX PVR M-6640N – Memory Card Reader + Internal Wifi + DVBT Dual digital TV

**\*\* Some specifications could change with new firmware versions. Please refer to the FAQ on our homepage for further information**

## Safety Notice

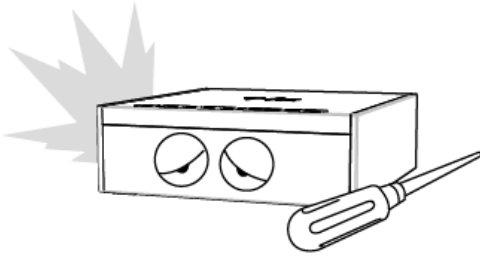

Do not try to disassemble or remodel the TVX-HD unit. Doing so may cause malfunction or fire.

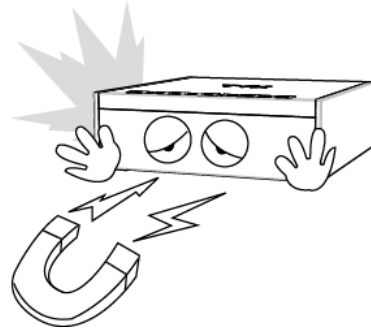

Place all magnetized devices, such as speakers, away from the TVX-HD. It may erase or cause damage to the data stored in the hard disk.

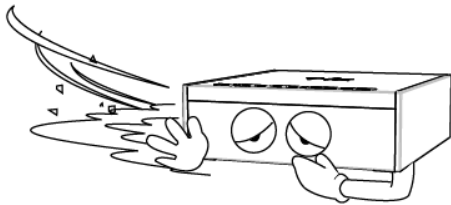

Do not place the TVX-HD in places that are exposed to oil, water, dust, humidity, rain or wind.

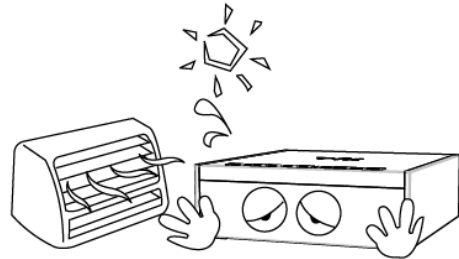

Keep your TVX-HD away from heated areas, such as direct sunlight exposure, heaters and etc. Place it in a well ventilated location. Ensure that a free airflow is maintained around the appliance.

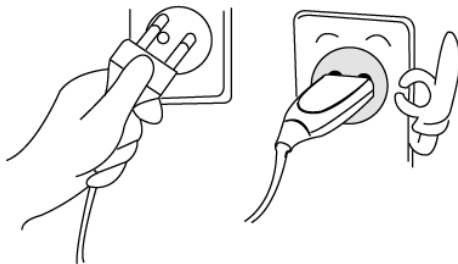

Do not touch the power plug with wet hands or use defective power cables & electric outlets. It may cause electric shocks or fire.

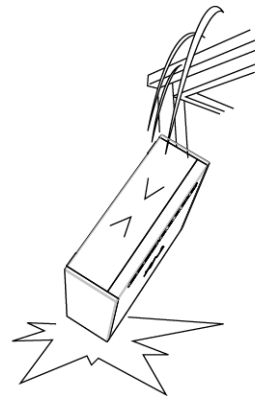

Do not drop the TVX-HD from heights. Doing so may cause critical damage to the hard drive.

**The socket-outlet shall be installed near the equipment and shall be easily accessible. Unplug the power cable when you are not using the product for a long time.**

## Usage Precautions

Thank you for choosing this TVX-HD product.

Please read the following usage precautions before using your TVX-HD.

### ● Connect the A/V cable

Make sure the power is off when you connect the A/V cable between the TVX-HD and TV.

### ● Cleaning the TVX-HD

When cleaning the TVX-HD unit, disconnect the power cord, and then wipe the TVX-HD case with a soft piece of dry cloth.

### ● Antenna connector

We recommend that you use a threaded-type antenna connector.

### ● Checking Digital signal Reception (PVR)

- Press the INFO button on the remote control. The Signal strength meter will appear on the INFO pop up.
- If signal strength meter indicates a weak signal, adjust your antenna to increase the signal strength. Continue to adjust the antenna until you find the best position with the strongest signal.

### ● Record Notice (PVR)

- The first partition of the internal hard disk must use the NTFS format. FAT32 format can cause an error message.
- When the signal is weak or unstable, recording cannot work properly.
- When the hard disk is unstable, recording cannot work properly. and this is why you should run Check Disk sometimes.
- You cannot use the DTV time-shifting on FAT32 partitions, so we recommend that you format your SATA HDD to NTFS.

### ● Connecting USB cable

When connected to a computer through an USB cable, TVX-HD acts as an external USB storage device (In this state, there is no video/audio output, and the VFD will indicate USB ON). For normal TVX-HD play mode, disconnect the USB cable connected to the computer, and turn on the TVX-HD.

### ● Detaching the Hard Disk

When you want to detach the HDD, let it cool down first before you start handling it.

### ● Supplied cables

Supplied cables and accessories are recommended for customized best performance of the TVX-HD. Using other cables or accessories may not provide the best performance.

### ● Unplugging the device from PC USB port

If you want to unplug the device, press the Stop button in 'Unplug or Eject Hardware'.

### ● FAT32 Partition

If you choose FAT32 file format on Windows 2000/XP, the drive's maximum size will be limited to 32GB. If you want to have a FAT32 single drive letter of 32GB or more, you have to format it on Windows 98SE/ME. We don't recommend the FAT32 partition to record the DTV channel.

### ● Wireless Network

To use a wireless network connection, please refer to the TVX-HD homepage for a list of compatible wireless devices.

### ● Certification sticker

The certification sticker mark is on the bottom of the device.

- DVICO has no warranty or responsibility for broken hard disks. We recommend periodic backups to prevent data loss.

\*\* Some functions will require you first to update it to the latest firmware.

## Table of Contents

Safety Notice .....	2
Usage Precautions .....	3
<b>1 Introduction.....</b>	<b>5</b>
1.1 HDTV PVR Function.....	5
1.2 Multimedia Player Function .....	6
1.3 Audio Player Function .....	7
1.4 External Storage Function .....	7
1.5 Specifications.....	8
<b>2 Name of Each Part.....</b>	<b>9</b>
2.1 Unit Control button.....	9
2.2 Cable Connection .....	9
2.3 Package Contents .....	10
2.4 HDD Installation/Exchange.....	11
<b>3 Installation and Connection.....</b>	<b>13</b>
3.1 Connecting the Video .....	13
3.2 Connecting the Audio .....	14
3.3 Connecting the USB HOST .....	15
3.4 Connecting the Antenna .....	15
3.5 Using the remote control .....	16
3.6 Initial Setting .....	17
<b>4 TVX-HD Setup Menu.....</b>	<b>18</b>
4.1 SYSTEM Setting.....	18
4.2 Audio/Video Setting .....	20
4.3 HDTV Setting.....	22
4.4 PVR Setting .....	23
4.5 NETWORK Setting .....	24
4.6 MISC Setting.....	26
<b>5 Initial Usage of TVX-HD.....</b>	<b>27</b>
5.1 Making an HDD Folder .....	27
5.2 Movie Playback.....	28
5.3 Music Playback.....	29
5.4 Photo Playback.....	30
<b>6 Using TVX-HD PVR.....</b>	<b>31</b>
6.1 Channel Scanning .....	31
6.2 Using TVX-HD PVR.....	32
<b>7 Using the remote control .....</b>	<b>39</b>
7.1 Descriptions of Each Button .....	39
7.2 Extra Features .....	45
<b>8 Using Network .....</b>	<b>49</b>
8.1 Using UPnP .....	49
8.2 Using NetShare .....	56
8.3 SAMBA Client and SAMBA Server.....	61
<b>9 Firmware Upgrade.....</b>	<b>69</b>
<b>10 Using USB Connection with a PC .....</b>	<b>71</b>
10.1 Making a Partition and Formatting the HDDs .....	71
10.2 Unplug or Eject Hardware .....	74
<b>11 Troubleshooting .....</b>	<b>75</b>
<b>12 Appendix - Technical Terms .....</b>	<b>76</b>
<b>13 GNU General Public License .....</b>	<b>78</b>

# 1 Introduction

## 1.1 HDTV PVR Function

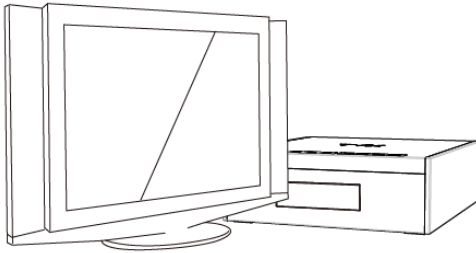

The TVX-HD PVR can play HDTV broadcasts without a digital TV set-top box, with excellent and super-clear pictures on HDTV screens. The TVX-HD PVR supports standard DTV features, such as EPG and Time-shifting.



TIME-SHIFTING

Time-shifting is a function that allows the user to record broadcasts, and save them in a storage device so that they can be viewed at a more convenient time for the user. When you are interrupted while watching a live TV program (such as picking up phone calls & answering the door), all you need to do is simply press the OK button to freeze the picture for a period of time, and then press OK again later in order to restart it from where you have left off. Note: You cannot use the DTV time-shifting on FAT32 partitions, so we recommend that you format your SATA HDD to NTFS.



RECORD

The TVX-HD PVR has various recording features, including direct recording, scheduled recording, and repeated manual recording, to help the user not to miss any programs on digital TV. It's a completely different type of PVR since you can easily upgrade and expand the HDD capacity yourself, which is similar to PC upgrading. And you can back up recorded files to/from a PC. In case of dual tuner, you can watch other channels while recording a program of your choice.



EPG

TVX-HD PVR implements DTV features such as EPG-scheduled recording and connection to PC, to let the user enjoy all the dainty bits of digital broadcasting as well as supreme audio and video qualities. You can set up scheduled recording and scheduled watching using the EPG window.



SLEEP

When using the DTV mode, you can easily reserve for sleep mode time with the FUNCTION key. If the sleep mode is enabled while it is still recording something, the TVX-HD will shut down after it finishes recording. In the file list mode, the FUNCTION key performs the File copy/delete and password functions.

DVICO Inc has no responsibility for recorded programs or files made or distributed for any illegal purposes. The party or parties who record or distribute contents bear all the responsibility (Civil or Criminal) direct or indirect.

## 1.2 Multimedia Player Function

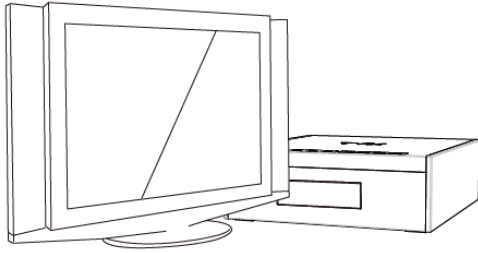

The TVX-HD is a standalone, multimedia hard disk player that plays digital videos, digital music, digital still images and DVD files on TV screens and home entertainment systems. You can enjoy digital contents in your living room without having to burn discs or to play it back on a DVD or CD player anymore.



TVX-HD plays back DVD movies with the full functionality of DVD navigation. You can create your own virtual DVD library by storing your personal collection of DVDs in .ISO or .IFO format, and watch them exactly as if they were running from the original DVDs (all the original features are included: Menu, Chapter, Audio Stream, Subtitle, Fast Forward, Rewind, Pause, Repeat, Search etc.).



TVX-HD can play high-definition videos (up to 1920x1080P) and still images. Pre-recorded HDTV programs from a digital TV set-top box or personal digital video contents recorded by a camcorder can be played back with the TVX-HD on a high-definition screen. The TVX-HD features an HDMI connector, which will match the high resolution of HD-level video contents.



TVX-HD supports the latest multimedia formats such as MKV, MPEG-4 AVC(H.264), VC-1( MP@HL, AP@L3), WMV9 & WMV HD as well as MPEG4 3.11,4.0 , 5.0. and H.264, which is a brand-new and superb compression technology. It can now play more stunning HD movies with lower storage requirements.



HDMI provides unparalleled qualities to digital videos and audios, while DVI only serves digital videos. With HDMI you don't have to deal with multiple AV cables. It lets you make a connection to digital videos as well as audios, and enjoy them with just one cable. It can deliver uncompressed digital video up to 1080P as well as digital audio.



TVX-HD has a DTS hardware decoder to mix DTS sound into 2 channels for a more dynamic stereo sound quality.



The TVX-HD can be networked with a PC system using either a wired network or its optional wireless network adapter. You can navigate to a PC file through TVX-HD's wired/wireless network and play the file from its original location without having to copy it into the TVX-HD first. Also, TVX-HD's FTP server and Samba server allow you to transfer files from your PC. It also allows you to connect to network easily with uPnP support, and it does not require an IP address. You can immediately playback uPnP connected files.



With two USB2.0 host ports, you can attach additional external USB hard drives to further extend the storage capacity. You can also play back files from a digital cameras, USB flash drives, USB flash card reader or an MP3 player.



Manufactured under license from Dolby Laboratories.

"Dolby" and the double-D symbol are trademarks of Dolby Laboratories.

### 1.3 Audio Player Function

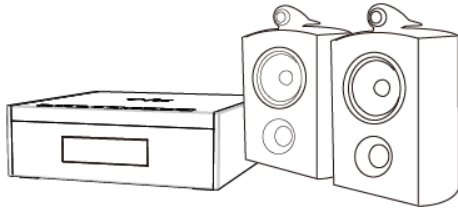

- TVX-HD can play a variety of audio files such as FLAC, MP3, Ipod, AAC, Ogg Vorbis and WMA (Windows Media Audio) through TV speakers and many other audio systems. You can listen to your favorite music files without hesitation, by organizing a custom winamp playlist. Now you can enjoy music all day long without having to keep changing CDs.
- TVX-HD supports playlist function that is based on \*.pls or \*.m3u.
- You can watch picture slideshows with the option of background music (supports Simultaneous playback of Audio and picture images).

### 1.4 External Storage Function

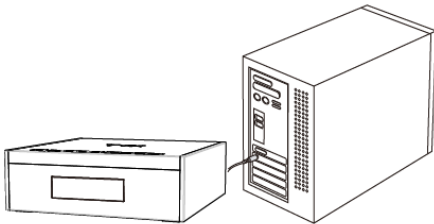

- TVX-HD can be used as an external storage device by connecting it to a PC, and you can then save videos audios image files, data, program backups and etc.
- USB 2.0 enables TVX-HD to support speeds up to 480Mbit/s.
- If you connect to a USB 1.1 port, the TVX-HD will work at USB 1.1 speed, so we strongly recommend that you use USB 2.0.
- It supports Plug & Play, Windows will automatically recognize TVX-HD the instant it is connected to the system
- If you connect a USB Cable between a PC and TVX-HD during a playback, the VFD will display "USB ON." Even when you disconnect the USB, you do not have to reboot the TVX-HD to continue using it.
- If you are a Windows98SE user, you should download a USB storage driver from our website before you connect your TVX-HD to your system. You do not have to install a driver in Windows ME/2000/XP.
- You can download the latest NetShare Software from our website to configure an NFS network server on your PC. If you select the NFS mode, you can play high bit-rate transport stream or DVD image files without any stutters.



## 1.5 Specifications

MODEL	TVX-PVR M-6640
Main Chipset	RT1283 400Mhz processor
VFD Display	7 Alpha-Numeric Character, 5 Digit Numeric Display
Video	Format: .MKV, .mpg, .avi, .wmv, .divx, .vob, .tp, .ts, .trp, .dat, .iso, .ifo, .m2t, .m2ts, .mov, .flv
	Codec: MPEG 1/2/4, AVI, XVID,WMV9(MP@HL),H.264( MP@HL4.1),VC-1( AP@L3), RealVideo
	Resolutions up to 1920*1080P
Audio	FLAC, DTS-Wav, MP3, WMA, WMA Pro, AAC, Ogg, Dolby Digital, WAV
	DTS Pass Through and Down Mixing
Photo	JPG, JPEG (Progressive JPEG not Support), BMP, PNG, GIF, TIF
Connectivity	USB 2.0 Host 2 Ports ( USB1/USB2 : 5V <sub>---</sub> , 500 mA max), USB 2.0 Target 1 Port
	Wired LAN, optional wireless LAN
	Network : Samba client, NFS, Netshare, Samba server
	Memory Card reader (6600N) : SD, SDHC, Memory Stick, Memory Stick Pro Duo
	TV Antenna port : 6640 – DVB-T dual tuner
Video out	HDMI 1.3, Composite
Audio out	Digital : Coaxial, Optical , Analog: Stereo
Hard Disk	NTFS, FAT32 (3.5" S-ATA HDD, supports S- ATA 1,2) PVR Recording & Time shifting : NTFS
Subtitle	smi, smil, sub, sub/idx, srt, .ssa, .ass
Cooling FAN	60mm Brushless FAN, Temperature Sensing, Variable Speed
Memory	256M byte
Power	AC 90-250~ 50/60Hz
Language	English, Traditional Chinese, Japanese, Spanish, French, Germany, Italian, Korean, Dutch, Russian, Rumanian, Bulgarian, Hebrew, Czech, Vietnamese
Size	215x70x215 mm (W x H x D)



## 2 Name of Each Part

### 2.1 Unit Control button

TVX-HD can be controlled by the buttons on the product as well as by the remote control.

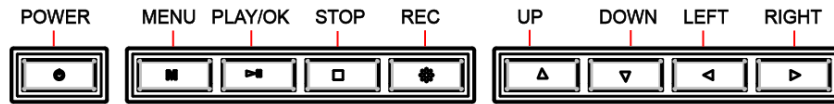

The current state of the product can be checked on the VFD on the front. The image of the VFD below could be different from the actual one.

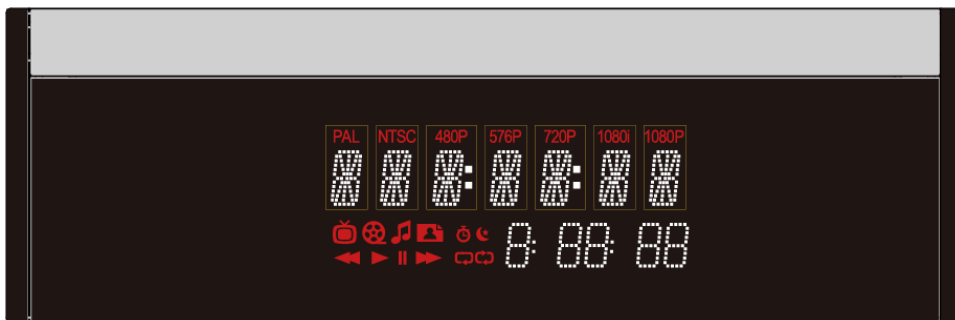

### 2.2 Cable Connection

You can connect the TVX-HD to an analog TV display or audio amplifier using the A/V cable.

In case of 6600N model, the Memory card reader is placed on the side of the unit.

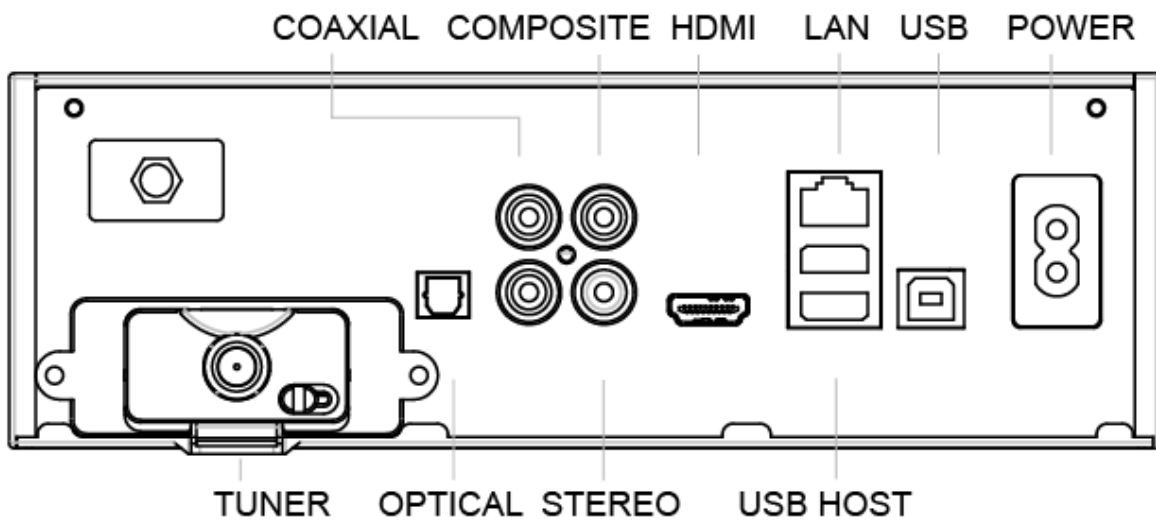

## 2.3 Package Contents

Thank you for choosing this TVX-HD product.

The TVX-HD PVR package contains the following items. The items described below may differ from the



TVX-HD unit



Remote Control

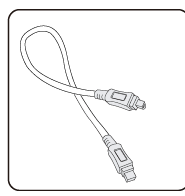

USB PC Cable

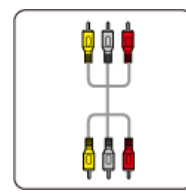

RCA Cable



Quick Guide

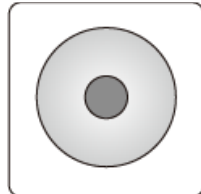

Manual CD

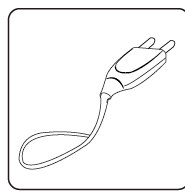

Power Cable

\* TVX-HD automatically formats when you install an unformatted new hard disk. Do not shut down the power when formatting the hard disk.

\*\* Connect the included power cable on the back of the TVX-HD. Then plug the other end of the power adapter into an available wall socket. Make sure that your TV is switched to the AV input to which the TVX-HD is connected (on the back of the TV).

### << Before Connecting the Cable >>

- 1 Please refer to TV manual for the connection of A/V cable.
- 2 Make sure the power is off when you are connecting the A/V cable between the TVX-HD and the TV.
- 3 Connect the red and white RCA cable for stereo audio.

## 2.4 HDD Installation/Exchange

\*\* Installing or exchanging your HDD is very easy. Just follow the instructions below. If you have a pre-installed HDD, you may skip this chapter.

- 1** Assemble the HDD guide and your HDD by using the screws included in the product package.

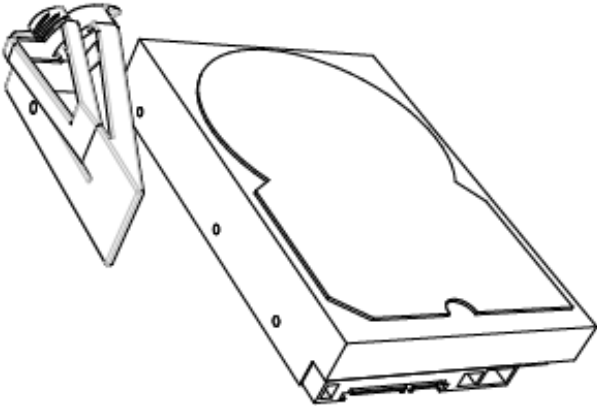

- 2** Open the lid of the TVX-HD as shown in the below picture.

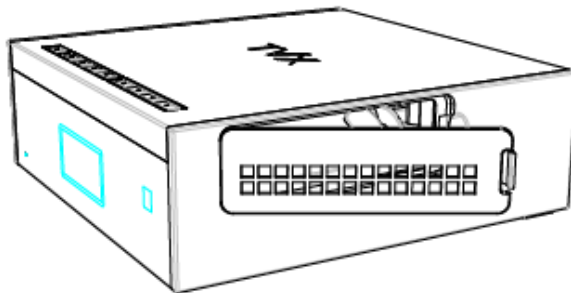

- 3** Position the HDD as in the below picture and then insert it.

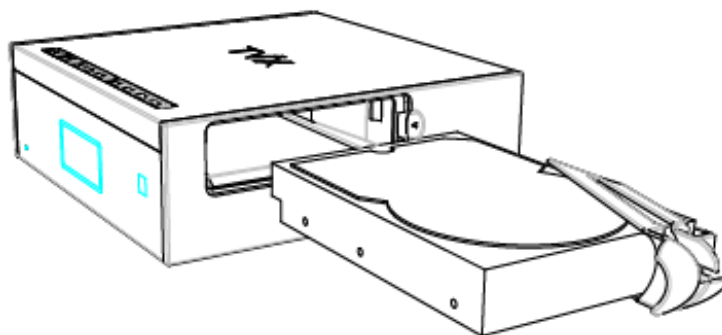

- 4** You don't need to connect any cables. Just push the HDD into the TVX-HD.

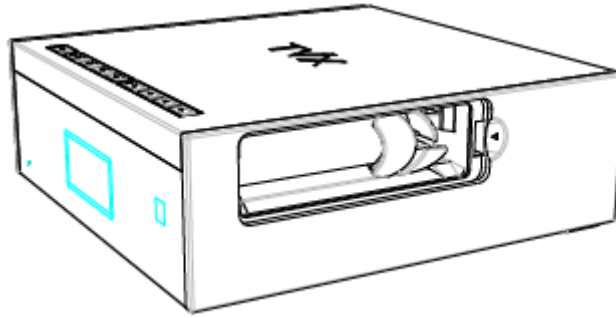

5 Close the lid of TVX-HD.

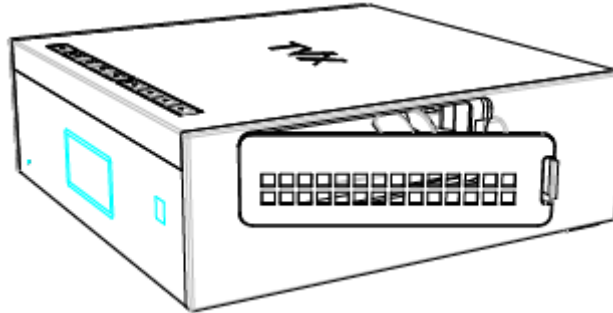

6 To change the hard disk, pull the HDD's guide out while pressing the lock button.

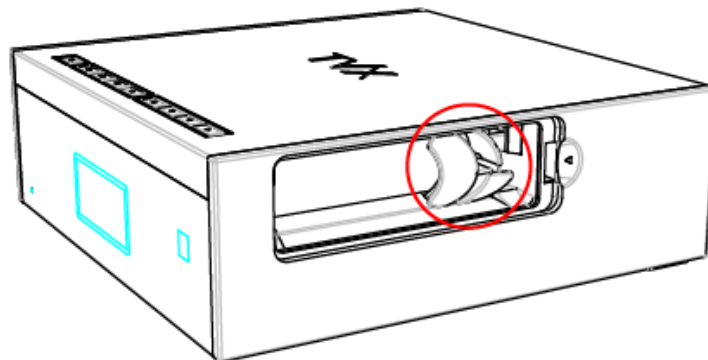

### 3 Installation and Connection

#### 3.1 Connecting the Video

The TVX-HD supports HDMI and Composite video output for connection to a TV, and each output needs to be selected in the settings menu depending on what cable is being used.

Connection to Composite

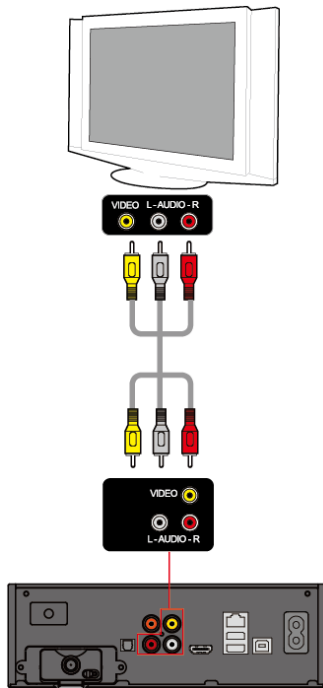

Connect the TVX-HD output to your TV using the included Composite (yellow) video cable. Select the appropriate video input mode on your TV until you get the main page of the TVX-HD. For the Audio, please connect the stereo cable (red/White cable).

Connection to HDMI Output

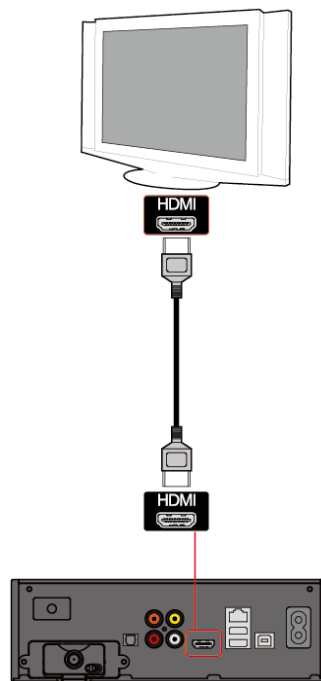

Connect the TVX-HD output to your TV using an HDMI cable. TVX-HD plays back high definition videos (up to 1920x1080P) by using HDMI cables. HDMI cable can transmit uncompressed audio and video signals together at the same time. No additional cables are needed.

**NOTE:**

After you connect the video cable to your TV, you must press the TV Out button on your remote repeatedly control until you see the main page of the TVX-HD on the screen.

### 3.2 Connecting the Audio

#### Connection to 2 CH Normal TV

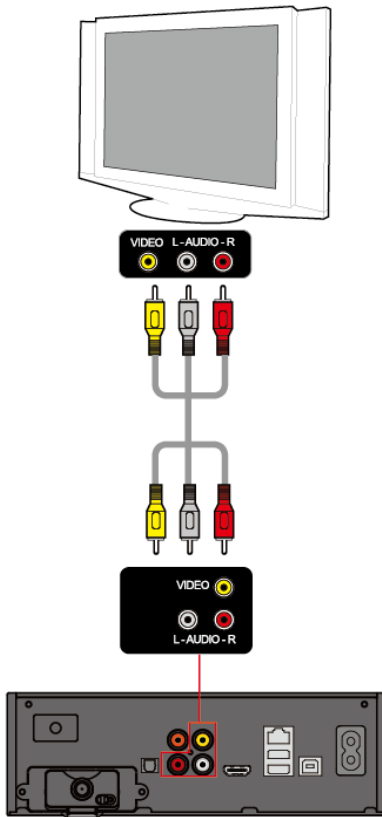

Connect the two audio cables, the white one on the left side and the red one on the right side, to the appropriate terminals of your TV or Hi - Fi system for sound output.

#### Connection to 5.1CH Amplifier (Digital)

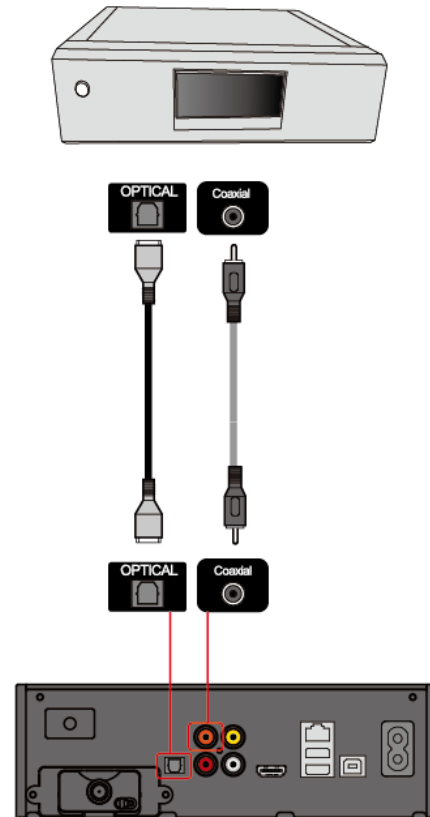

If you have a multi-channel decoder/amplifier with a coaxial/optical input, you can enjoy 5.1 CH high-quality sound through the coaxial or optical cables. The illustration above shows how to connect the optical cable with an included optical jack.

(These cables are not included in the package and must be purchased separately.)

#### NOTE

If there is still no sound after connecting the coaxial/Optical cable, you have to change the audio setup of TVX-HD to Digital on the SETUP menu.

### 3.3 Connecting the USB HOST

The TVX-HD also provides two USB-host ports with USB 2.0 compliant host/ function processor.

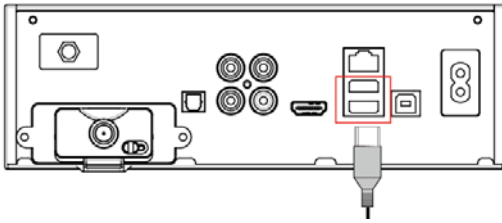

USB-host allows communication between two USB devices. You can connect any external storage device (e.g. memory stick) or any external hard disk to play files stored in these external devices. You can even connect your Digital Camera directly to play digital images and pictures without any other devices.



After connecting the client device, press the left-arrow button on your remote control, and then navigate to the desired storage unit. You can thereby change the location from internal hard disk to external USB device and back.

### 3.4 Connecting the Antenna

- 1 Before connecting the Antenna or R.F. cable, the power of TVX-HD must be turned off.
- 2 To improve the picture quality in a poor signal area, please purchase a signal amplifier and install it properly.
- 3 We recommend using a threaded-type antenna connector. Move it clockwise to tighten it.
- 4 If the signal strength meter does not reach even half of the scale, adjust your antenna to increase the signal strength. Continue adjusting the antenna until you find the position that gives the strongest signal.

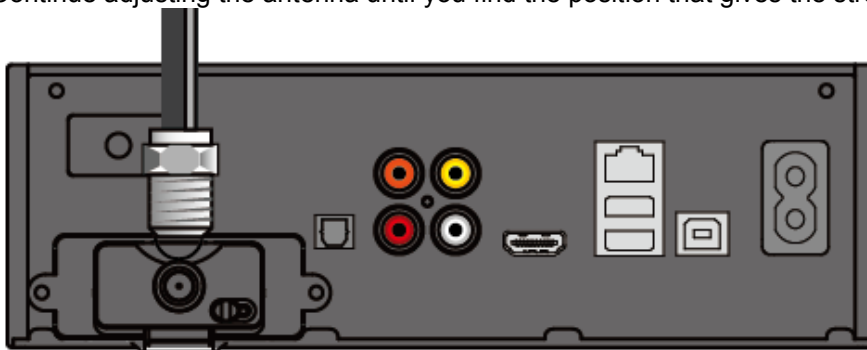

- ◆ TVX-HD M-6600A – optional DVB-T dual tuner
- ◆ TVX-HD M-6600N – Memory Card Reader + Internal Wifi + optional DVB-T tuner
- ◆ TVX PVR M-6620N – Memory Card Reader + Internal Wifi + ATSC Dual digital TV

\*\* Connect the included power cable at the back of the TVX-HD. Then plug the other end of the power adapter into an available wall socket. Make sure that your TV is switched to the AV input to which the TVX-HD is connected (at the back of the TV).



### 3.5 Using the remote control

This indicates Remote control Buttons.

POWER		Toggle Unit Power on / off
MUTE		Stop Audio Output from the Player
HDTV		Switch between TV or DTV mode
MOVIE		Go to Movie folder
MUSIC		Go to Music folder
PHOTO		Go to Photo folder
Numeric Key		Insert number or text
16:9/4:3		Aspect ratio(16:9/4:3 letter box/4:3 Pan&Scan)
ZOOM		Zoom Video / Image Playback
PREV		Previous Chapter / File / Page Up on List
Next		Next Chapter / File / Page Down on List
JUMP/REW		Jump to USB Host or network drive
SORT/FF		File Sort or FF playback
OK/TIMESHIFTING		Selection/play/pause/time-shifting on/pause
ARROW		Cursor Navigation Arrow/Rewind / FF playback
RETURN		Stop Playback/Return to Previous Screen / Folder
VOL + / -		Volume (Increase / Decrease)
CH + / -		Switch TV channel/adjust subtitle sync
INFO		Display Media File Information
SUBTITLE		Subtitle ON / OFF, Change Settings
FAVORITE		Switch favorite channel
GOTO		Time-Stamp based Search/TV channel list
SETUP		Enter Setup Menu, Apply/Confirm Setup Settings
AUDIO		Select multi audio
REPEAT		Repeat Media file(s) Playback
SHUFFLE		Switch between Random – Sequential Playback
TV OUT		Toggle Video Output Modes
TITLE		Select subtitle file
MENU		Display Main Menu Screen/ DVD Title Screen
FUNCTION		File copy/ folder password/ Sleep Timer
GUIDE		Display DTV EPG Guide
BOOKMARK/SCH		Bookmark / manual recording in TV mode
ADD/DELETE		Add/Remove the recording list/ delete file
REC		Instant recording in DTV



Some buttons have different functions in PVR mode and file play mode.

### 3.6 Initial Setting

**1** Connect the TVX-HD to your TV using A/V cables, and turn on the TVX-HD. You will see the following screens when you turn the unit on for the first time or when you select “Load Default Setting”.

**2** When you see the initial page on your TV screen shown in the picture below, press the “OK” button on the remote control.

- In case of HDMI connection: TVX-HD does not show this page but sets to the best resolution automatically and leads you to the next stage, “Language setting”.
- In case of other connections: TVX-HD changes screen resolutions between NTSC, PAL, 480P, and 576P about every three seconds until the “OK” button is pressed, so press the “OK” button when you can see a clear screen.



**3** Select the language.





**4** Now you can see the TVX-HD main page.

## 4 TVX-HD Setup Menu

### 4.1 SYSTEM Setting

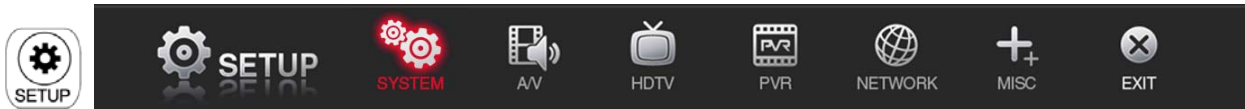
This section is about SYSTEM (Language or Time) settings. Press SETUP button on the remote control and select SYSTEM.



This screen allows you to adjust the SYSTEM settings of your TVX-HD to your personal taste. Select  menu to exit this SETUP. Press 'NEXT' button to move on to the next setup.

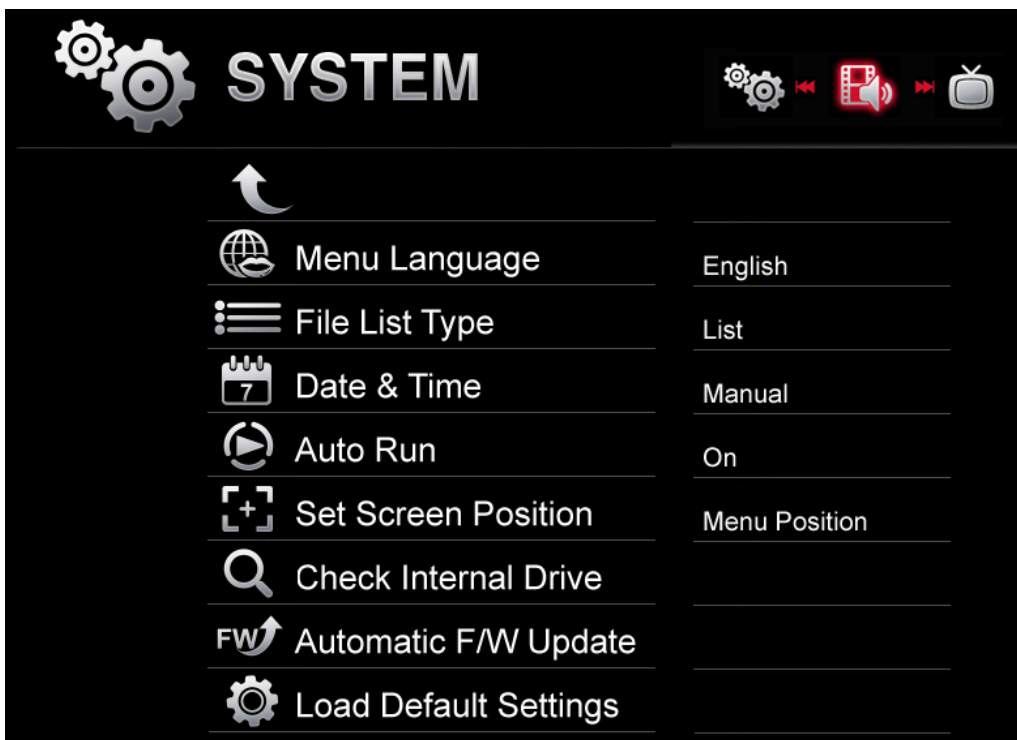

 **Menu Language** : Select your language.

 **File List Type** : Switch to File list mode ,Preview or icon mode.

List mode

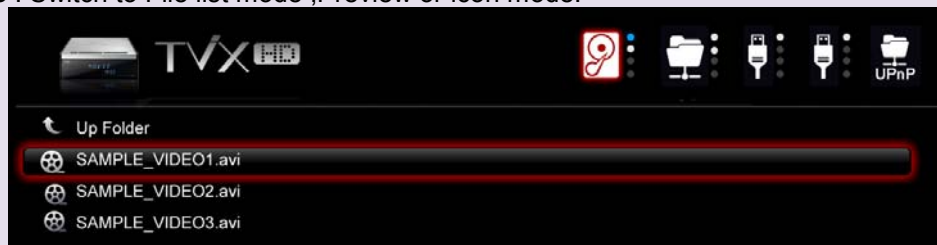

Preview mode

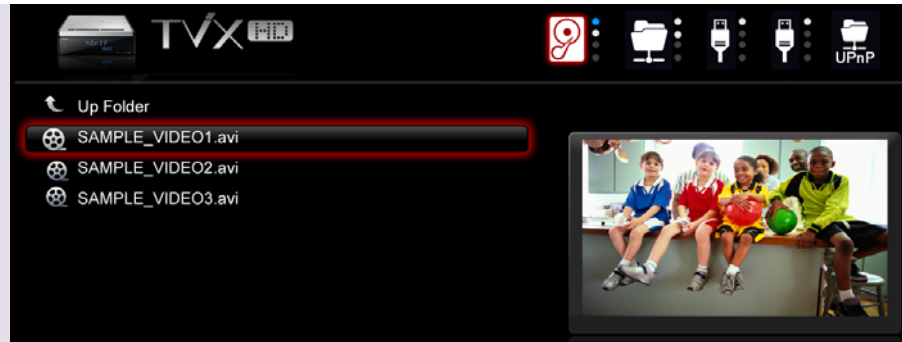

Icon mode



**Date & Time** : Adjust the clock by using the arrow and numeric keys. With a DTV tuner, Auto (Via TV or Via Network) is also available. Press Left/Right button on your remote control to move to another option. Press Up/Down button on your remote control to make changes on the setting.

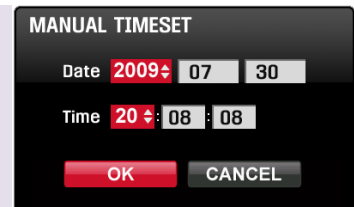

**Auto Run** : You can make files play automatically when TVX-HD gets loaded. If you select “random”, they play in a random order.



**Set Screen Position** : Adjust the UI display position, so that you can see the main UI display at the right place on your TV. Arrow buttons and OK button are available.

1. Adjust Left - Top blue line.
2. Adjust Right - Bottom blue line.



**Check Disk** : TVX-HD provides HDD check utility. If you have any problem with recording or file playback, we recommend running this utility before proceeding. TVX-HD automatically formats when you connect an unformatted hard disk to the TVX-HD. Do not shut down the power while the hard disk is being formatted.



**Automatic FW Update** : Now you can upgrade a new firmware if your TVX-HD is connected to the internet. To upgrade it with our beta version of firmware, please press 2,3,8,2 of the numeric keys and then press the 'Function'.



**Load Default Settings** : In order to revert to the Default setting, select this option. You will need to configure the video and sound settings again.

## 4.2 Audio/Video Setting

This section is about A/V (Video or Audio) settings. Press SETUP button on the remote control and select the A/V.



This screen allows you to adjust the A/V settings of your TVX-HD to your personal taste. Select  menu to exit this SETUP. Press 'NEXT' button to move on to another setting.

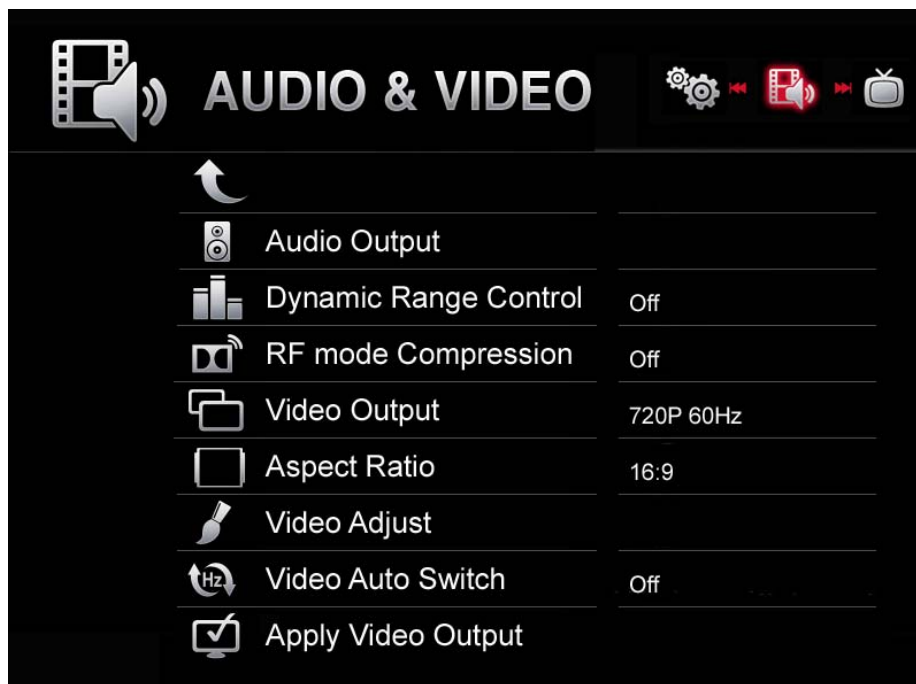

Set the **audio output** setting.

Select the HDMI or the S/PDIF that you want to hear the audio.

If you select the S/PDIF, you can set the detailed audio output with your Decoder/Amplifier. We recommend you to set the Dolby Digital and DTS to digital and AAC to analog.

You don't need set this option when you connect RCA cable.



**Digital Audio output (Digital RAW) :** Select this when you connect the audio with an coaxial/optical cable for digital audio connection to the Decoder/Amplifier.



**Dynamic Range Control :** This function is for either decreasing high level sounds or increasing low level sounds.

[ON]: low volume at late night.

[OFF]: full dynamic range of the volume.



**RF Mode Compression :** This function keeps approximately constant average loudness levels between different audio formats. Users do not need to adjust their volume control as they switch between program services.

Turn it off to enjoy full dynamic range of Dolby Digital.

cable. With HDMI setting, you can select an output resolution between NTSC,PAL, 720p 50hz/60hz, 1080i 50hz/60hz and 1080P. 1080i should work on all HD grade TVs.



**Aspect Ratio** : 4:3 Letter Box / 4:3 Pan & Scan for ordinary TVs; 16:9 for Wide TVs, such as HDTV or Plasma TV.

If the ratio of the TV is 4:3, select the 4:3 letter box or 4:3 Pan & Scan. If the ratio is 16:9, select 16:9.

\* The 4:3 Letter box can show the original ratio of the multimedia file in 16:9.



\* The 4:3 Pan & Scan will adjust the image of the 16:9 multimedia file to the 4:3 of the TV screen by scaling the image. (This mode is currently not supported)



\* 16:9 can adjust any ratio of the multimedia file to the TV screen with the original image.



**Video Adjust** : Set the Brightness - Contrast - Hue - Saturation.

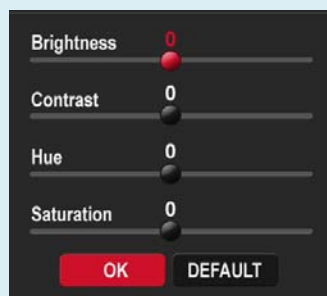

Press OK or STOP button to save and exit current video setting.



**Video Auto Switch** : is used when the video out is changed according to the 1080P 24Hz format.



**Apply Video Output** : press 'Apply Video output' to save current Video output mode.







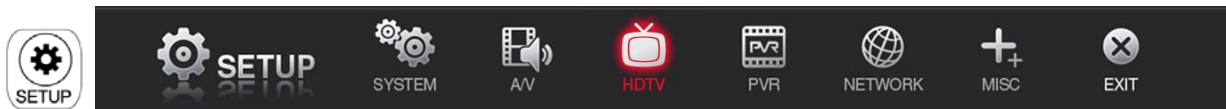

### 4.3 HDTV Setting

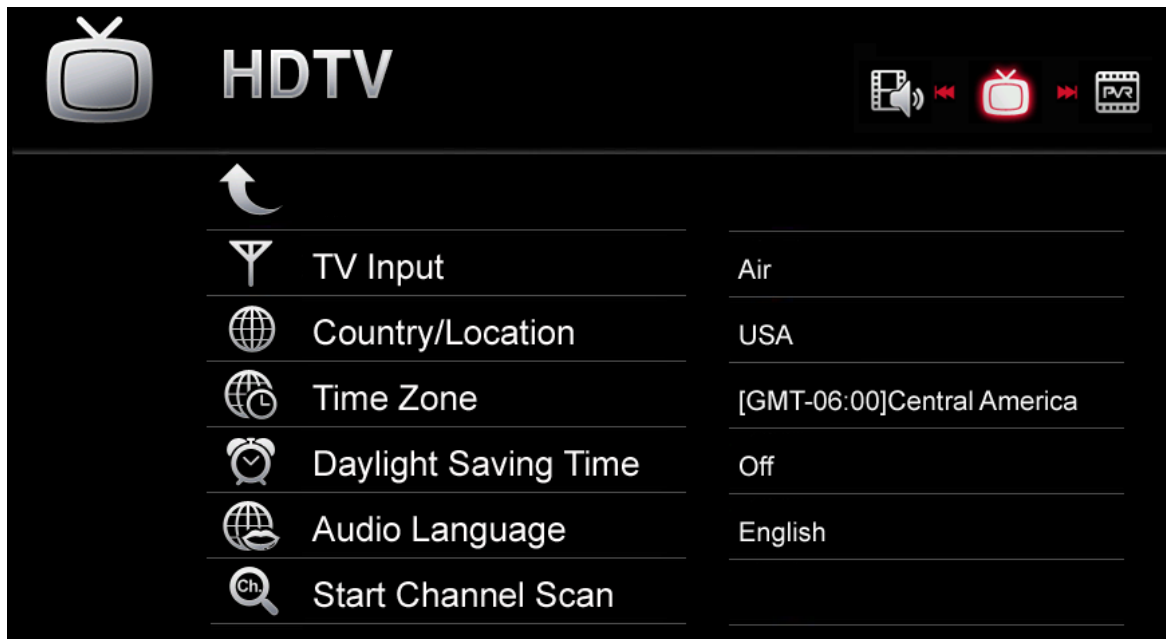
This section is about HDTV settings. Press the SETUP button on the remote control and select HDTV.



This screen allows you to adjust the HDTV settings of your TVX-HD to your personal taste. Select menu to exit this SETUP. Press 'NEXT' button to move on to the next setting.



- 
**TV Input** : Select your input.
  - ◆ TVX-HD M-6600A – optional DVB-T dual tuner
  - ◆ TVX-HD M-6600N – Memory Card Reader + Internal Wifi + optional DVB-T dual tuner
- 
**Country/Location** : Select your country or location.
- 
**Time Zone** : to use the EPG guide with the correct recording time zone, you have to configure your time zone by using the arrow keys.
- 
**Daylight Saving Time** : set this option on if you are in the area of DST.
- 
**Audio Language** : select default audio. To change the audio format, press the AUDIO button on the remote control.
- 
**Start Channel Scan** : Press 'Start Channel Scanning' if you want to scan the channel.

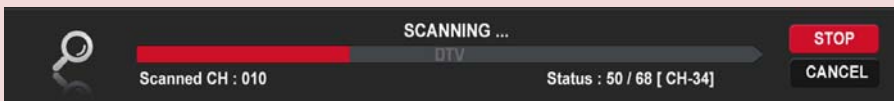



## 4.4 PVR Setting

This section is about PVR settings. Press the SETUP button on the remote control, and select PVR.

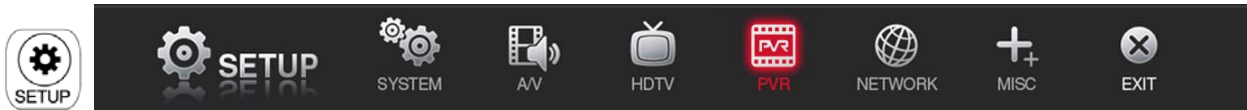

This screen allows you to adjust the PVR settings of your TVX-HD to your personal taste. Select menu to exit this SETUP. Press 'NEXT' button to move on to the next setting.

This setting will be activated when you connect the tuner box.

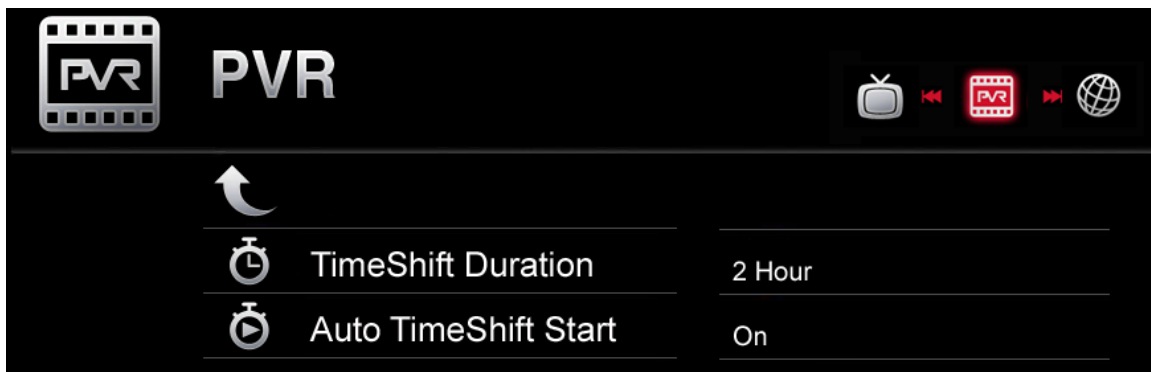

**TimeShift Duration** : Set the maximum time-shifting interval.



**Auto TimeShift Start** : Time-Shifting automatically starts when the product is switched to TV mode.

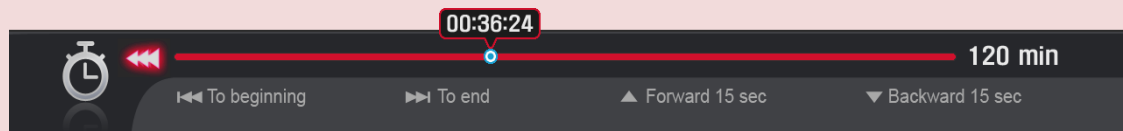

## 4.5 NETWORK Setting

This section is about NETWORK (Network or FTP) settings. Press the SETUP button on the remote control, and then select NETWORK.



This screen allows you to adjust the NETWORK settings of your TVX-HD to your personal taste. Select  menu to exit this SETUP. Press 'NEXT' button to move on to the next setting.

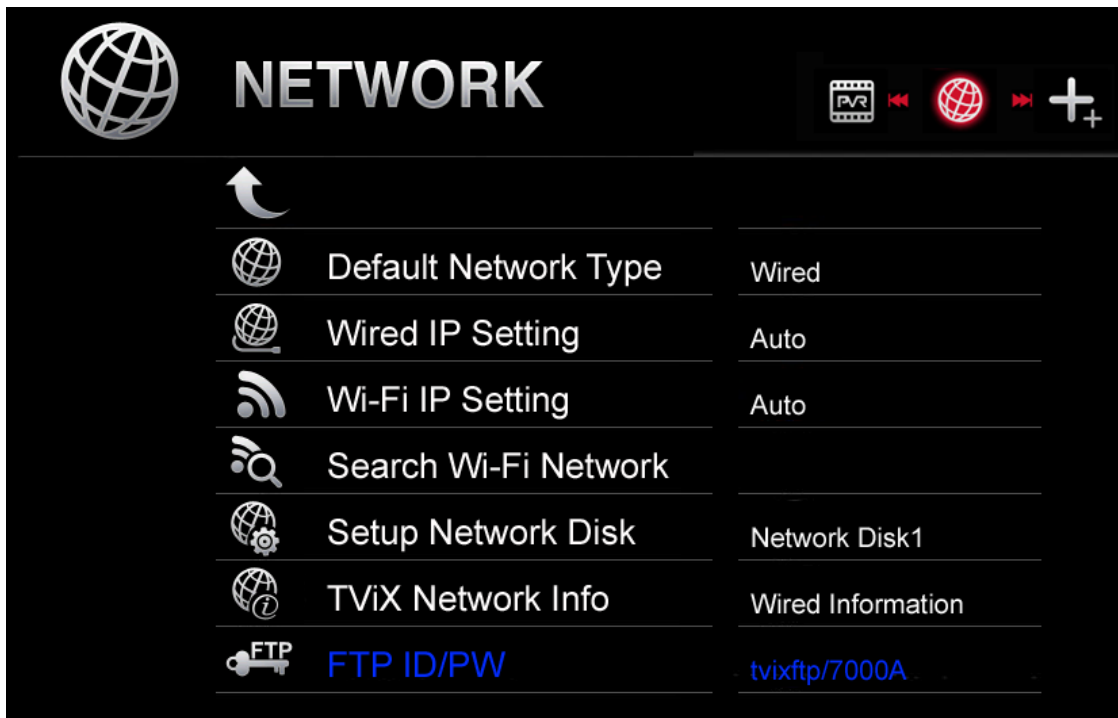

**\*\* For detailed Network instructions, please refer to the enclosed TVX-HD CD or the latest pdf file on the TVX-HD Homepage.**

It allows you to connect to network easily with uPnP support, and it does not require an IP address. You can immediately playback uPnP connected files (even full HD files) on wired/wireless network environment.

With Samba Server technology support, it can be used as a network storage device using a window explorer for PC users, and it can also be used like a computer hard disk by specifying the shared folder between users in the same network as a network drive.

With NFS, TVX-HD can play high bit-rate files from a PC flawlessly over a LAN. We recommend NFS connection over SAMBA. You need to install the TVX-HD Netshare program (or other NFS server) on the server PC, but the settings are much easier than in SAMBA mode. You can download NetShare installer from our website to easily configure your NFS network.

To use the network with the Netshare, first please connect TVX-HD into PC with USB cable to be authenticated once.



**Default Network Type :** Select Wired network or Wireless network.



**Wired IP Setting:** Default setting is DHCP. If you cannot access via LAN with DHCP setting, use the Static IP setting. For a static IP, refer to the **LAN Connection**.



**Wi-Fi IP Setting** : Default setting is DHCP. If you cannot access via LAN with DHCP setting, use the Static IP setting. For a static IP, refer to the **LAN Connection**.



**Search Wi-Fi Network** : Connect the USB module to TVX-HD after connecting the AP Router to a PC. Press “Search Wi-Fi Network” to search for your AP or AP router. Spend some time searching for it, and you will see the AP LIST popup menu. Select the AP that you want to connect to.

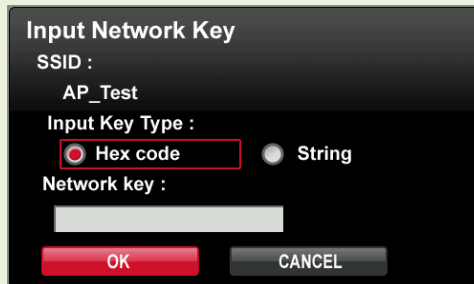
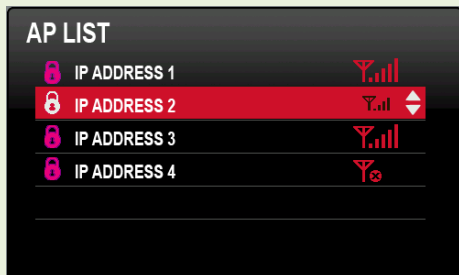

**Setup Network Disk** : This function searches and helps you find PCs connected to the network. SAMBA: If you have a guest account, shared folder names can be listed and can be selected. NFS: Connected PCs are listed automatically in NFS of NAS storage or Netshare. In case of Netshare, if you select a tvixhd1 or tvixhd2, IP of PC is displayed.

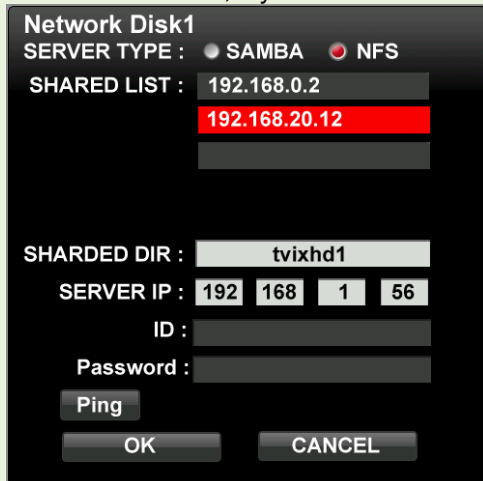

**TVX-HD Network Info** : You can see the information of TVX-HD's Network.

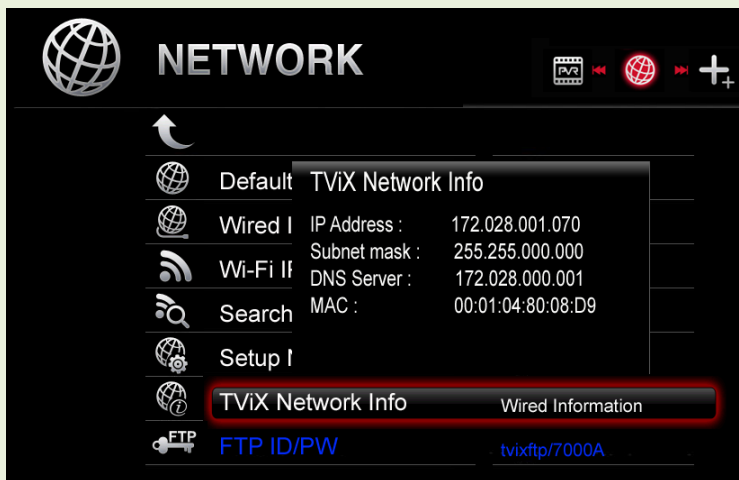

**FTP ID/PW** : to use FTP function, you must use the ID & password displayed on the Network in Menu within SETUP. The FTP ID is tvixftp. You can use capital letters only for the password.

## 4.6 MISC Setting

This section is about MISC (Photo effect and Subtitle) settings. Press the SETUP button on the remote control, and then select MISC.



This screen allows you to adjust the MISC settings of your TVX-HD to your personal taste. Select menu to exit this SETUP. Press 'NEXT' button to move on to the next setting.

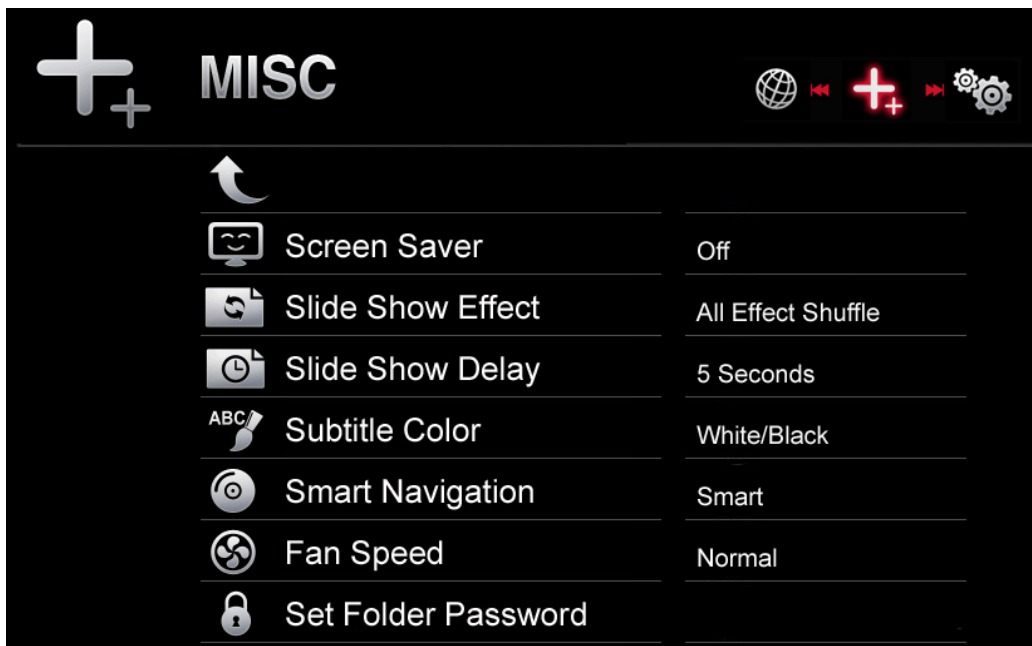

**Screen Saver** : If there is no activity the screen saver will be activated after a certain time. You can change the Screen Saver time on this menu.



**Slide Show Effect** : is used when playing background music while watching picture a slideshows.



**Slide Show Delay**: Set the slideshow time interval.



**Subtitle Color** : Change the color and outline of subtitles.



**Smart navigation** : If there is a VIDEO\_TS.IFO file in the folder, clicking on the DVD folder will automatically play back .VOB content.



**Fan Speed** : Select theFan Speed. We recommend the Normal setting.



**Set Folder Password** : In order to password-protect folders, firstly you will need to setup the Admin Password. Default Admin Password: 0000 (4-zeros). Perform the SETUP-SYSTEM-Load default settings if Admin Password gets lost.

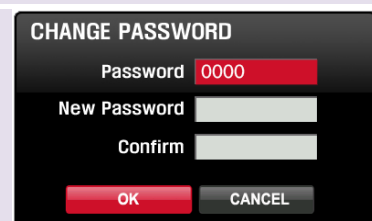

## 5 Initial Usage of TVX-HD

### 5.1 Making an HDD Folder

**1** As shown in the picture below, one end of the USB cable should be connected to the USB connector of the TVX-HD, and the other end to the computer.

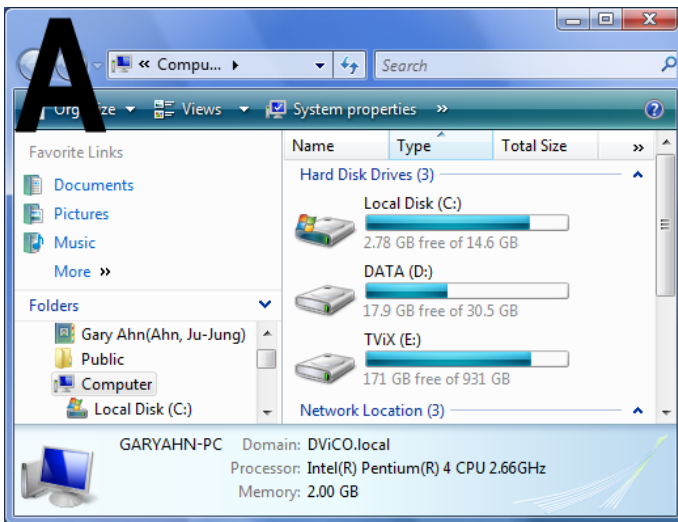
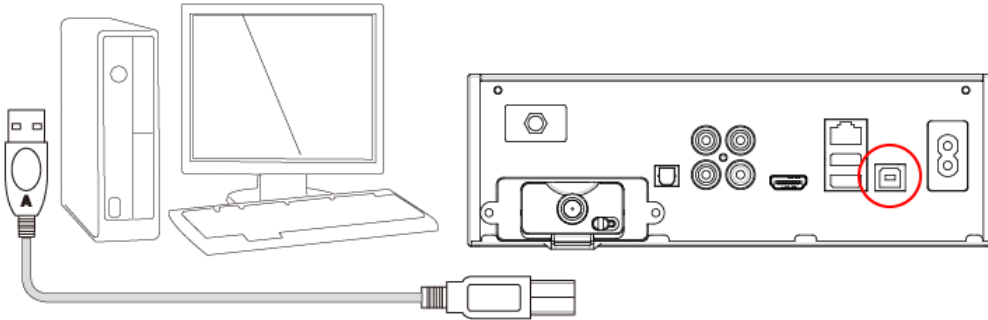

**2** After connecting to the PC, turn on the power of the TVX-HD.

**3** Double click on the icon 'My Computer', and you will see a newly created drive; TVX-HD as shown in picture 'A'.

( The name of the drive can be changed.)

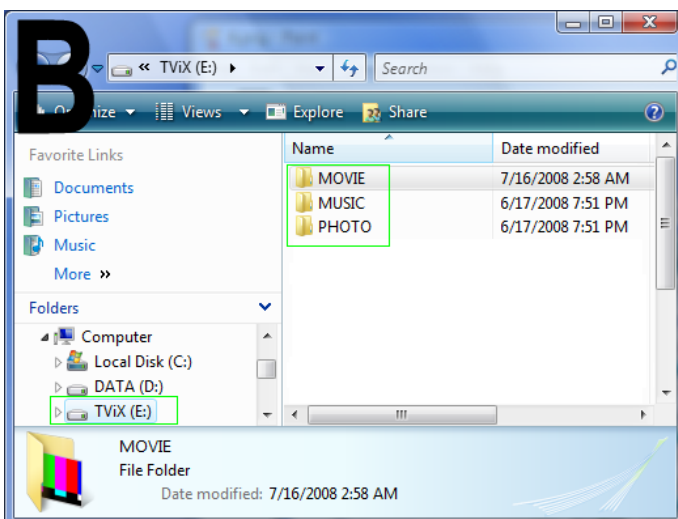

**4** For easy usage, double click TVX-HD and make separate folders and name them as MOVIE, MUSIC, and PHOTO. Then store all your files accordingly to each folder.

## 5.2 Movie Playback

When installation is successfully finished, you will be able to see the Main MENU screen. You'd better copy a video file into the MOVIE folder in advance.



**1** HDTV, MOVIE, MUSIC, PHOTO, SETUP icons are shown.

**2** Select the MOVIE menu by using the Up/Down arrow button on your remote control.



**3** After selecting the icon, press the

OK (  ) button.

**4** If you want to change the partition of the HDD, press the Jump/Left button.

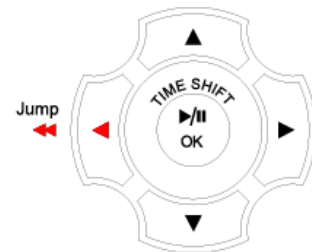

**5** Using the up/down button, select the Video file content.

By pressing the OK (  ) button,



you will be able to play the video file.

### TIP ~

If you want to play the next video, press the NEXT (  ) button.

If you want to play the previous video, press the previous (  ) button.

### 5.3 Music Playback



You can copy audio files to the MUSIC folder in advance and play music files..

**1** If you cannot see the MAIN MENU screen, press the

MENU(  ) button on your remote control.

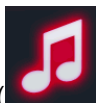

**2** Select the MUSIC menu(  ) on the Main screen and press the

OK(  ) button.



**3** You will see the audio file contents that you have just copied.

**4** Select the audio file content using the up/down button. Then by pressing the OK button on the content highlighted you will be able to play back the audio file.

**TIP ~**

If you want to play the next audio, press the NEXT(  ) button.

If you want to play the previous audio, press the previous(  ) button.



## 5.4 Photo Playback

You may copy image files into the PHOTO folder in advance and play the image or photo files.



**1** You can press the PHOTO button on your remote control without selecting from the menu screen



**2** Press PHOTO (  ) button.

**3** You can see the image files that you just copied.



**4** Select the image files using the up/down button. By pressing the OK button, you can easily play the image file content.

**5** If you want to play the next image, press the NEXT(>>) button.

**TIP ~**

You can play the HDTV, Music and Movie as well as the Photos with the remote control.



If you connect the LAN cable or external USB, Network or USB icon is enabled on the main Menu . We're supporting up to 4 hard disk partitions, 4 network PC, 4 USB1 partition and 4 USB2 partition.



## 6 Using TVX-HD PVR

- The TVX-HD PVR can play HDTV without a digital TV set-top box with excellent and super-clear display on HDTV screens. The TVX-HD PVR supports standard DTV features, such as EPG and Time-shifting.
- The TVX-HD PVR has various recording features, including direct recording, scheduled recording, and repeated manual recording, to enable the user not to miss a single program of digital TV..
- Time shifting is the recording of programming to a storage medium to be viewed or listened to at a time more convenient to the consumer. Being interrupted while watching live TV programs (such as pick up phone calls & answer the door), all you need to do is simply press the OK button to freeze the picture for a period of time and then later press OK again to pick up right where you left off.
- TVX-HD PVR doesn't support satellite reception.
- DVICO Inc has no responsibility for recorded programs or files made or distributed for any illegal purposes. The party or parties who record or distribute the contents bear all responsibility (Civil or Criminal) direct or indirect.

- ◆ TVX-HD M-6600A – optional DVB-T dual tuner
- ◆ TVX-HD M-6600N – Memory Card Reader + Internal Wifi + optional DVB-T dual tuner

\*\* Without internal tuner box, some functions of PVR ( EPG or Channels) will not work.

### 6.1 Channel Scanning



- 1 When installation is successfully finished, Press SETUP(  ) - HDTV on your remote control.
- 2 To scan the channels, you can use the Start Channel Scan menu on the SETUP-HDTV menu.

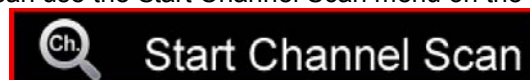

- 3 To improve the picture quality in a poor signal area, please purchase a signal amplifier and install properly.
- 4 The channel scan takes about 5~6 minutes.

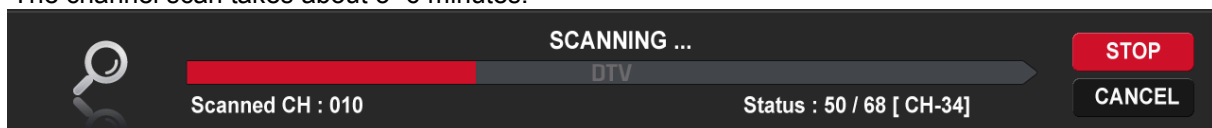

- 5 To stop the channel scanning, Click on OK(  ) button on the remote control or select the STOP on the scanning window.
- 6 After scanning, you have to configure the time zone on SETUP-HDTV, If you want to use the EPG guide, you have to set your time zone correctly.

#### ※ Checking Digital signal Reception

- ① Press the INFO button on the remote control.
- ② The signal-strength meter will appear on the INFO window.
- ③ If the meter indicates weak signals, adjust your antenna to increase the signal strength. Continue to adjust the antenna until you find the best position with the strongest signal.



TVX-HD displays  on screen when you press an invalid key.

\* To delete scanned channels, press GOTO - choose channel - ADD/DELETE button.

## 6.2 Using TVX-HD PVR



: Select HDTV icon on the main menu to play the HDTV mode ( Without tuner box, this menu is not available.)



: Press HDTV button on your remote control to switch the TV mode

### 6.2.1 Channel switching

- 1 Press CH +/- button to change the TV channels.
- 2 You can also enter the channel number by using the numeric keypad on the remote control and the channel will change after a few seconds.
  - Previous Channel( SHUFFLE button).



- 3 To check the scanned-channel list, press the GOTO button(  ) in DTV mode.



You can change the channel by using Up/Down and OK button.

- 4 Press Add/Delete button, and you can add the channel to favorite channel. You can change the favorite channel by clicking the FAVORITE button.

In case of dual tuner, You can watch other channels while recording a program you want.



### 6.2.2 Instant recording

- This function records the currently displayed channel.
- In case of dual tuner, You can watch other channels while recording a program you want.
- Select the desired channel to record while watching and then press the REC button(  ) to record.
- Press the STOP button (  ) to stop recording, or, when the recording duration is reached, the TVX-HD will stop recording.
- The recorded file is stored to the hard disk of the TVX-HD in a folder named PVR.
- The file is saved with a name of the form “YY-MM-DD\_program name.tp”
- The hard disk must be formatted using the NTFS file system. If the FAT32 file system is used, an error message appears sometimes.
- livepause folder is a temporary folder for time-shifting, so you may ignore this folder name.

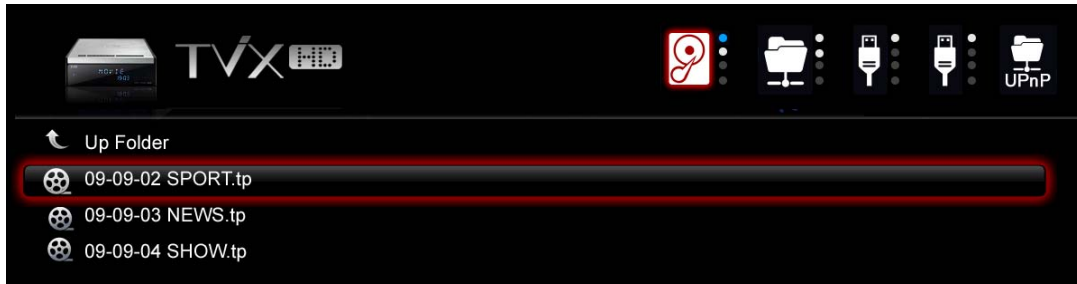

- Clicking on the REC button (REC) changes the recording duration in the sequence shown below. Free Space->30min->60->90->120->180->240. When recording, you can see red-round OSD(●) on the right-top of the screen.

**OTR:90 Min.**



- When recording, Press the INFO button (INFO) on the remote control, and you can see recording information.

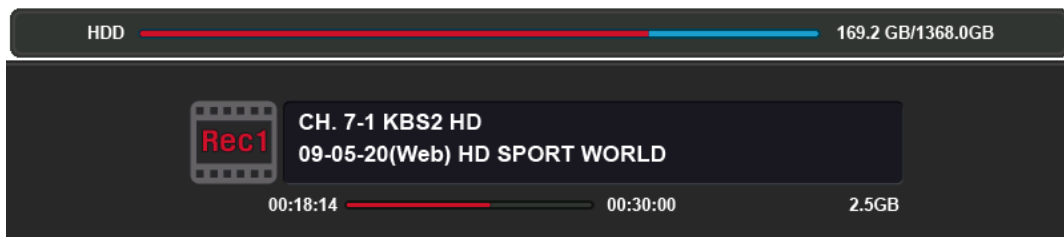

- When recording, press the Add/delete button, the recording will be canceled.
- When recording, if the available storage space runs out, the recording will automatically stop.
- The information about the current broadcast program can be seen when you press the INFO button

(INFO) while viewing broadcast programs.



- If the available hard-disk space is less than 50MB, recording will not work. If the available hard-disk space reaches 10MB or less when a recording is in progress, it will stop automatically and show “No space” on the OSD.

**Record Notice**

- The first partition of the internal hard disk must use the NTFS format. FAT32 format will cause an error message.
- When the signal is weak or unstable, recording cannot work properly.
- When the hard disk is unstable, recording cannot work properly. So you must sometimes run Check Disk.



### 6.2.3 Using DTV EPG Guide

DTV EPG (Electronic Program Guide) shows the guide obtained from the real-time broadcast data stream.



Press the Guide button (GUIDE) in DTV mode to see an EPG window similar to that shown below. Select the desired channel to record or watch and then press the View or Record button to tune the channel or schedule the recording.

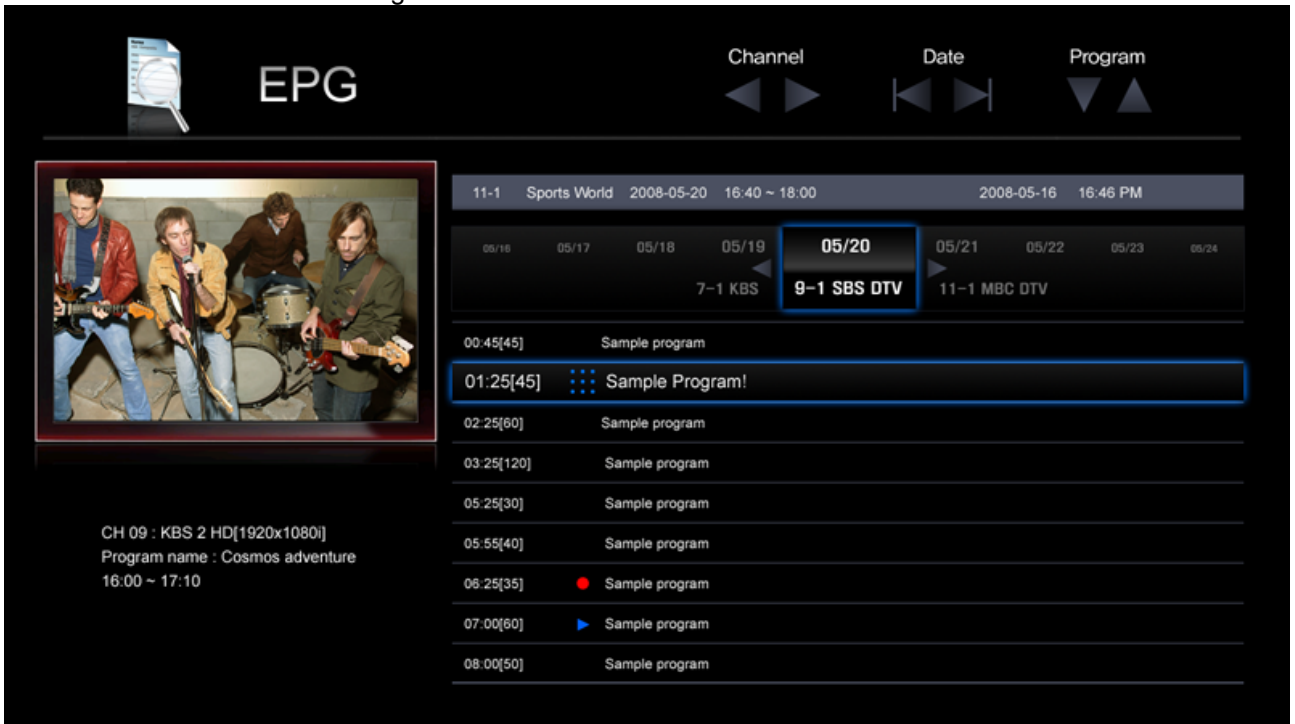

Open/Close an EPG Guide window.



Change the displayed EPG Date backward.



Change the displayed EPG Date forward.



Change the displayed EPG channel.



Change the EPG list highlighted item.



Select the program to schedule by using up/down button and press OK button.

#### Add a new Schedule

Choose a schedule type.

Start : 17:12[58]  
Channel : 7-1 KBS2 HD  
Program : HD SPORT WORLD

Recording Watching CANCEL

In order to record by auto-rebooting when the TVX-HD is off, the TVX-HD has to be off 3 minutes before the recording time. It will automatically switch to TV mode and start recording. When the TVX-HD is on, it starts reserving at the reserved time.

### 6.2.4 Manual Recording

**1** Setting up of manual recording reservation can be done in TV mode or in file list mode. In TV mode,

press the BOOKMARK/SCHEDULE button (  ). Manual reservation bases on the time shown on VFD. Please set the date as auto(Via TV) mode in SETUP-SYSTEM before you do the manual reservation.

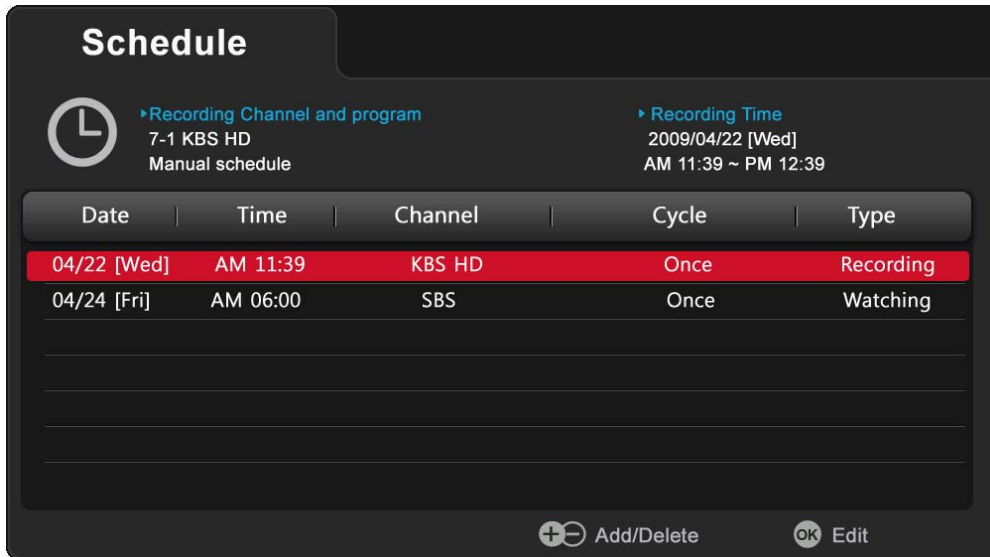

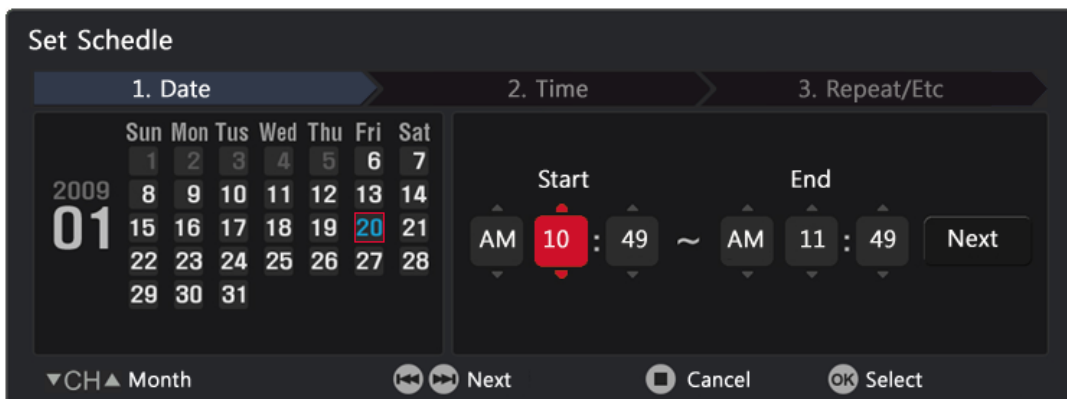

**2** Press ADD/DELETE button (  ) in order to manually reserve for recording. Reservation set up goes through three steps. After the set up for the reservation date is done, press OK in order to set up the starting time and finishing time. Midnight twelve o'clock is AM 12:00.

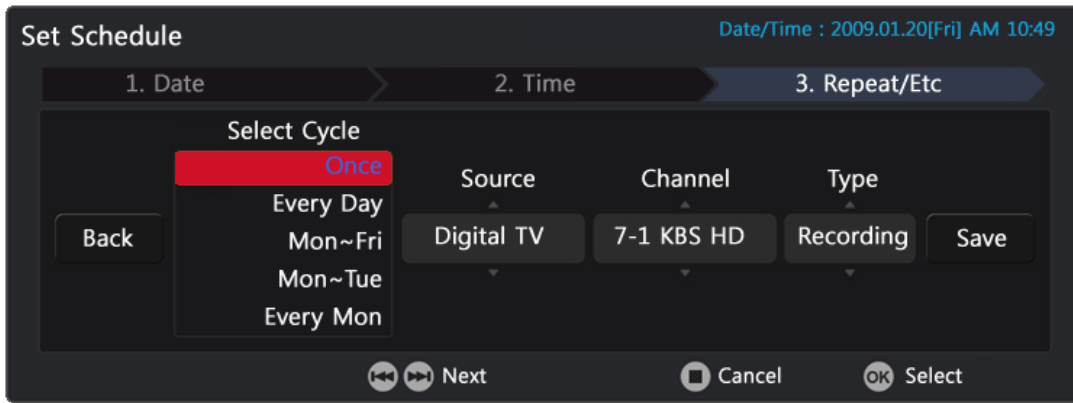

**3** Set up the recording period in the Repeat selection section. Repeat selection section changes depending on the day of the week. Set the input device as Digital TV, and then choose the channel that you want to reserve for recording. There are recording reservation and viewing reservation available.



Reservation steps could be rearranged when you press the Next Content button (   ) on the remote control.

**4** In order to play the recorded files, press MOVIE, switch to File Mode, and then select the recorded file. Or you can also press BOOKMARK/SCHEDULE button, select Recording List, and then play the recorded file.

**5** You can play a recorded file on the REC list.

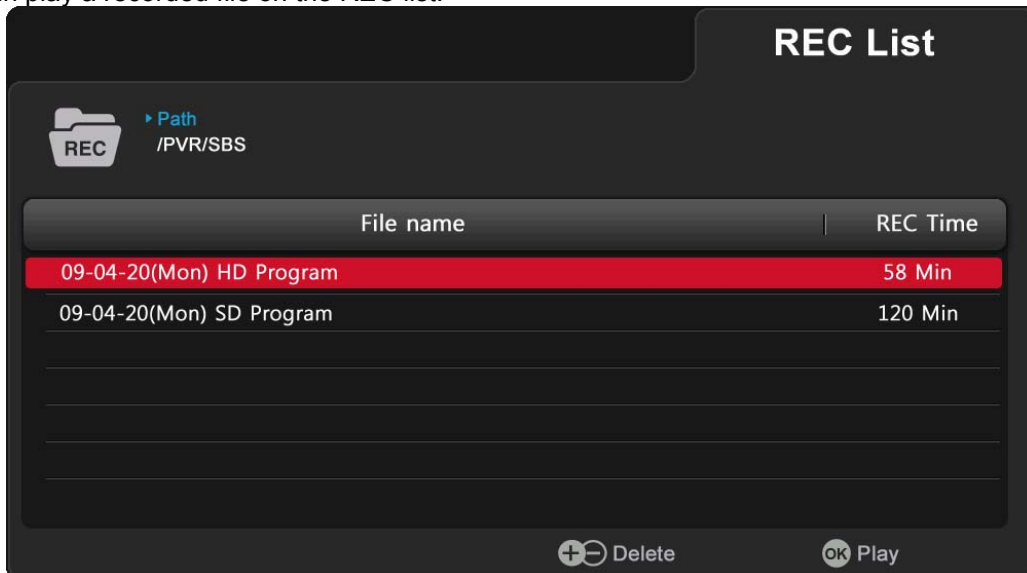

**6** In order to record by auto-rebooting when the TVX-HD is off, the TVX-HD has to be off 3 minutes before the recording time. It will automatically switch to TV mode and start recording. When the TVX-HD is on, it starts reserving at the reserved time.



### 6.2.5 Using Time-Shifting

Time shifting is the recording of programming to a storage medium to be viewed or listened to at a more convenient time. If interrupted while watching live TV programs (for example, to pick up phone calls or answer the door), you simply press the OK button to freeze the picture for a period of time and then later press OK again to pick up right where you left off. The Time-shifting buffer is preserved when you change the channel.

Note: You cannot use the DTV time-shifting on FAT32 partitions, so we recommend that you format your SATA HDD to NTFS.

DTV Time shifting requires a maximum HDD space of 9G/hour.



Start/Pause the time-shifting function. Pressing the button alternately starts pausing or resumes from pausing to watch the TV in time-shifting mode.

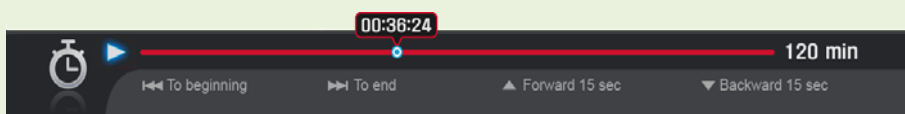

Stop the time-shifting function and display live TV.



Go to the start position of the time-shifting buffer.



Go to the Live position (end of the time-shifting buffer).



FF/REW in time-shifting mode.

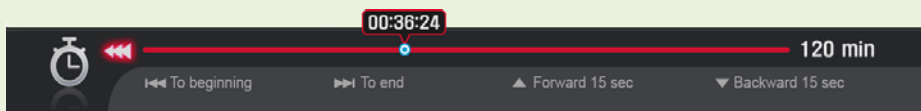

you simply press the Up or Down button to jump 15 seconds.

\* Pressing the Zoom button while you are playing files, you can change the screen as ZOOM +/- --> screen Scroll --> save.

## 7 Using the remote control

### 7.1 Descriptions of Each Button

Basically, for playback of multimedia files you choose the file you want by navigating to it with the menu buttons and left/right and up/down arrow buttons and then press the OK button.

#### 7.1.1 Video Playback

When you press the MOVIE button () on your remote control, the TVX-HD MOVIE folder contents are displayed on the TV Screen.

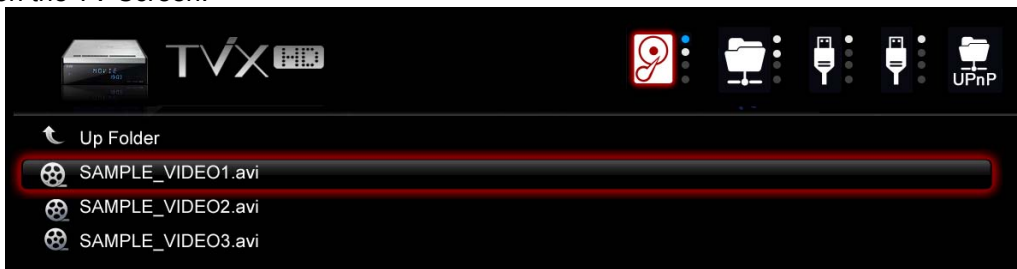











This only applies to the active partition if you have more than one partition.

Press the JUMP () button on your remote control to select another input source.

TVX-HD displays  on screen when you press an invalid key..

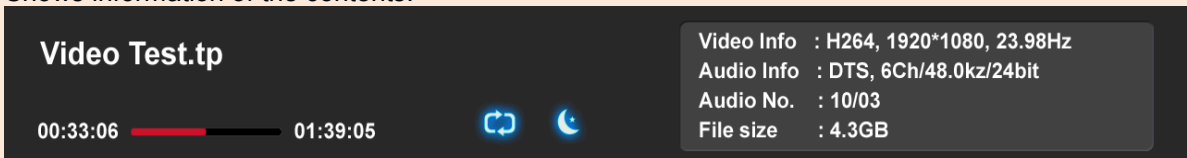
#### <NOTE>

	Play or pause file. 
	Stop playing a file. 
	Go to the next file. 
	Go to the previous file. 
	Shows information of the contents.
	
	Pressing Info button while you are not playing files shows remaining HDD space. 4:3 Letter Box / 4:3 Pan & Scan for ordinary TVs / 16:9 for Wide TVs such as HDTV or Plasma TV. If the ratio of the TV is 4:3, select the 4:3 letter box or 4:3 Pan & Scan. If the ratio is 16:9, select 16:9.

① The 4:3 Letter box can show the original ratio of the multimedia file in 16:9.



② The 4:3 Pan & Scan will adjust the image of the 16:9 multimedia file to the 4:3 of the TV screen by scaling the image. (Currently this mode is not supported)



③ 16:9 can adjust any ratio of the multimedia file to the TV screen with the original image.



Pressing the Zoom button while you are playing files, you can change the screen

Vol + : change from 1X to 9X.

CH+/- : change 0% ~ 180%

Left/Right/Up/Down : Scroll the screen.

Zoom and scroll function will be default when you stop the video.



Subtitle color or outline is configurable on the SETUP-MISC menu.

Supports .SUB (bitmap) + .idx subtitle files as well as MKV internal subtitle or smi external subtitle

Some subtitle is not available to change the subtitle position, size or sync.

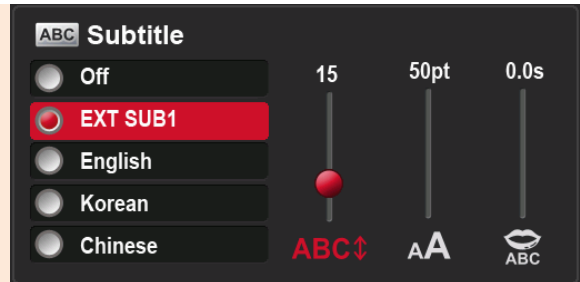

Select subtitle you want and press right button on your remote control to change the position, size or sync of subtitle.

Change Subtitle Position :

Change Subtitle Size :

Change Subtitle Sync :

You can also change the subtitle sync by using CH +/- button on your remote control.



Pressing GOTO button while you are playing files, You can choose the time. After choosing you can play directly. The present playing time will be displayed with the GOTO function.



**FF/REW Button**  
Pressing FF button while you are playing files, you can change the FF mode. 2X→4X→ 8X →16X → 32X.

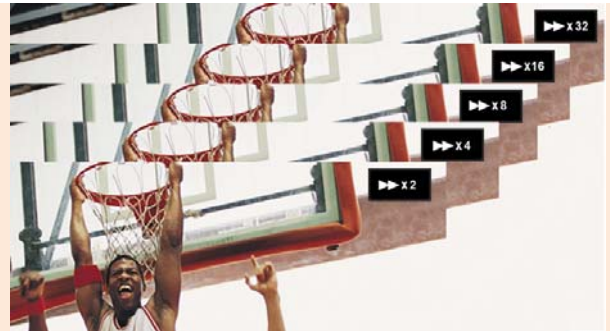

Up/Down Button : 15 seconds skip forward or backward.

15 SEC (Down button) : Back 15 seconds.  
15 SEC (Up button) : Skip 15 seconds.



is used to delete the file or folder from the TVX-HD Local hard disk. When you do delete files or folders, you must run the HDD check disk periodically.



During playback You can set sleep time by pressing function key repeatedly on a remote control. SLEEP ON will blink for 3 minutes before turning off.



In these menus, you can adjust the Contrast, Brightness, Hue and Saturation as well as other setup settings.



If you stop when playing a movie, the stop position will be automatically saved and you can resume it later anytime by pressing the "bookmark" button on the remote control.

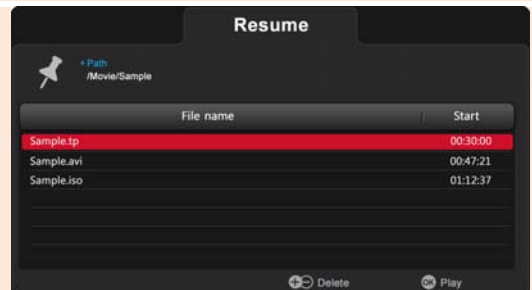

- save up to 32 bookmarks on 32 individual files. (It cannot save 2 bookmarks on a single file.)
- Bookmarking works for all video files.
- A video file where the folder is setup with a password cannot be saved.
- When replaying the same file, only the last play position will be saved (thus, bookmarked).
- A file deleted from the hard disk will be automatically deleted from the bookmark list as well.



Pressing AUDIO button while you are playing multi audio files, you can change to alternate audio tracks.



Select the subtitle file manually. (require updating to the latest firmware)



Adjust the play mode to repeat Track, repeat All or repeat off.









### 7.1.2 DVD Navigation

For playback of DVD files copied to the HDD, navigate to the **VIDEO\_TS.IFO** file and press OK.

Full DVD navigation works as with a standard DVD player.



#### < DVD Jukebox Keys >

	Play/Pause (when a movie is playing). Select file (in the menu screen).
	Stop playing.
	Go to the next chapter
	Go to the previous chapter
	Show DVD information.
	MENU : Go to the DVD root menu.
	FF/REW Button Up/Down Button : 15 seconds skip or 15 seconds backward.
	AUDIO: Change the audio the available tracks. (International dubbing, Dolby Digital, 2CH, 5.1CH, DTS etc.)

\*\* The operation of “arrow” and “VOLUME UP/DOWN” is the same for Video operation.

### 7.1.3 Audio Playback



When you press the MUSIC button(  ) on your remote control, the contents of the TVX-HD Music folder will be displayed.



It applies only to the active partition(first partition) if you have more than one partition.











TVX-HD displays  on screen when you press an invalid key. If you press audio file, then you will get the screen of music window. You can choose another song to hear in this music window.



\*\* Some functions may require updating to the latest firmware.

**< NOTE >**

	Play or pause file.
	Stop playing
	Go to the next file.
	Go to the previous file.
	Show the information of the audio file. If there is no Tag information, it displays basic file information.
	FF/REW button. CH Up/Down Button : 15 seconds skip or 15 seconds backward.
	Shuffle Function (Random Playback), Press the Shuffle button to play the files of the present directory randomly.
	REPEAT : Adjust the play mode to repeat Track, repeat All or repeat off.

### 7.1.4 Image Playback

When you press the PHOTO button(  ) on the remote control, the contents of the TVX-HD PHOTO folder will be displayed.

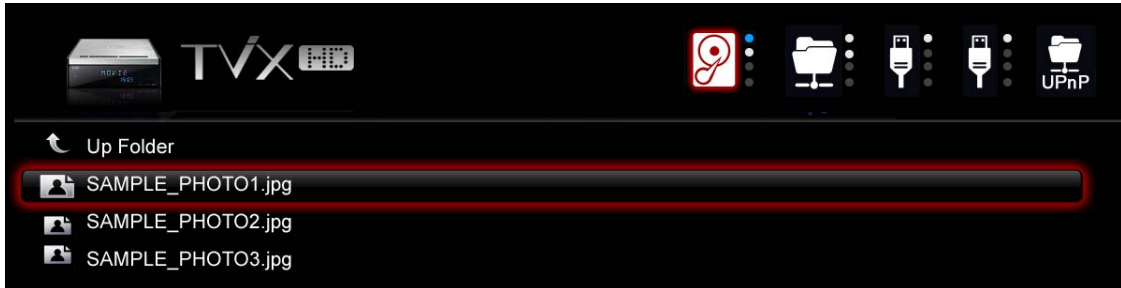

It applies only to the active partition(first partition) if you have more than one partition.

TVX-HD displays  on screen when you press an invalid key.

**< NOTE >**



Play or pause file.



Stop playing



Go to the next file.



Go to the previous file.



Show the information of the image.



Rotate the image.



You can change and set the size of the picture with the ZOOM.



With Zoom mode, you can scroll the image by pressing the arrow buttons.

- You can set the slideshow delay or slide show effect at the SETUP-MISC menu.
- Some non-standard JPEG files may not be displayed..[Progressive jpeg is not supported].
- You can use the Background Music Slide function if there are audio files and image files in same folder.



## 7.2 Extra Features

### 7.2.1 Using the AutoRun Function

When you want to play music with the TVX-HD, but do not have any display devices, the following function may come in handy.

- 1 Make a folder and name it, "autorun" and place it in the root directory of the First partition.

Name	Date modified
Autorun	8/1/2008 2:27 AM
Movie	8/1/2008 2:27 AM
Photo	8/1/2008 2:27 AM

- 2 Copy media file(s) or a list file in the "autorun" folder.

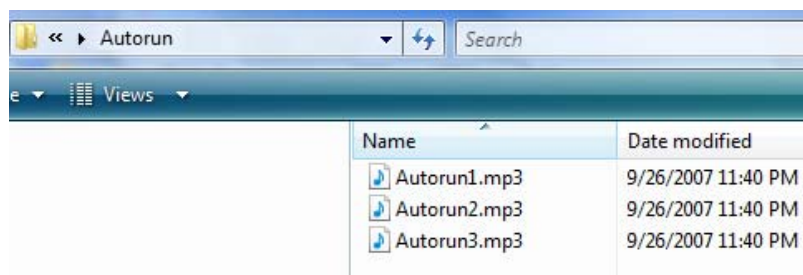

- 3 If you want to change the setup, push the SETUP button on the remote control. Then go to the SETUP-SYSTEM tab. Set AutoRun option to ON. If you set the AutoRun option to OFF, the function will not work. If you select 'Shuffle,' files will play randomly.

- 4 After setting the configuration, turn off the TVX-HD and then turn it on again. The TVX-HD will play the media file from the under '/HDD1/autorun'.

#### << Using WinAMP Playlist ( .m3u or .pls ) >>

- 1 Connect TVX-HD to PC.
- 2 Use the "Winamp" application to form a playlist of files stored on the TVX-HD.. (See figure below)
- 3 Select Save playlist from the Winamp File menu and save the list on the same partition where the opened files are stored.



- 4 Disconnect TVX-HD from PC by using Safely Remove Hardware tray icon.



## 7.2.2 Using playlist

TVX-HD allows you to make/edit a playlist without you having to turn on your PC.

- 1 Move to a folder where you want to create a list, and then press the FUNCTION button.

From the set-up image(as shown below), select the playlist image. (  )

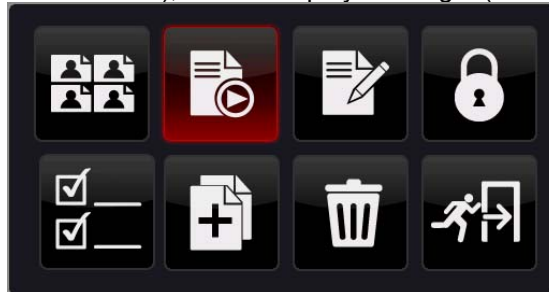

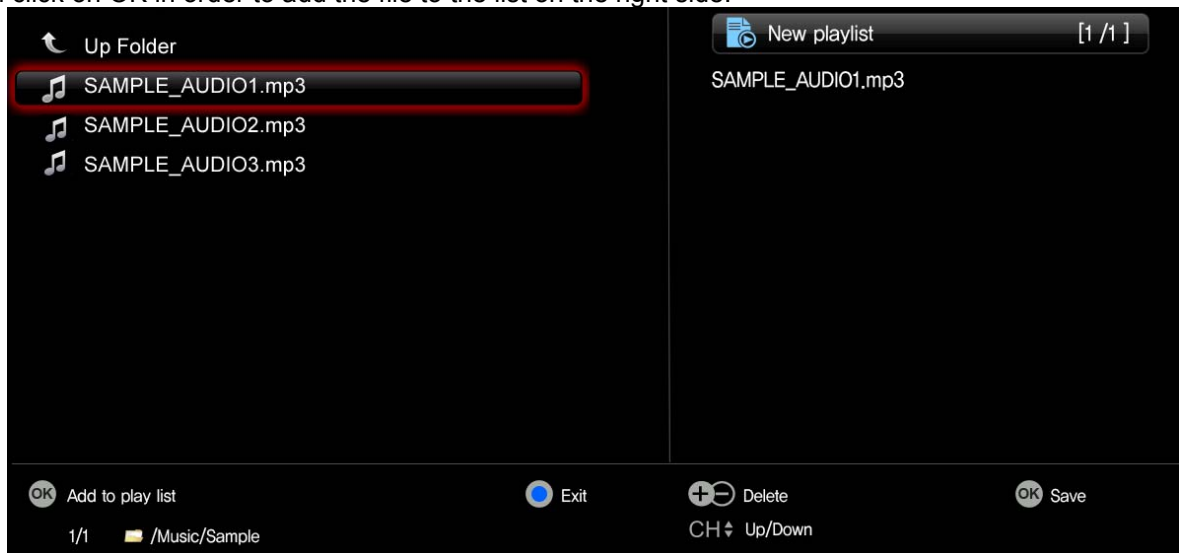

- 2 Playlist addition is separated into two windows. Select a file that you want to add from the left window, and then click on OK in order to add the file to the list on the right side.



You can move around between the two windows using left/right direction keys.

 Left window : make additions to the playlist, Right window: save the playlist file

 Leave the playlist window. If you leave without clicking on OK on the right window, the list does not get saved.

 Remove the selected list from the right window.

 Change the order of playback on the right window.

- 3 Completed list(playlist xx.m3u) is saved where you pressed on FUNCTION, or the place you started to make a playlist.

Since the location is fixed, if you wish to save it in a particular folder, create a folder, and then select the playlist addition button in that particular folder

- 4 If you want to edit list files, go to list file(playlist xx.m3u), select FUNCTION, and then select the “edit list”

icon(  ).

\*\* Image file is not available when adding the play list.

\*\* It will not play the file if the location of the saved list file is changed.

### 7.2.3 Using File Copying

TVX-HD supports File Copy functionality without Using PC. You can now copy Contents from external USB hard disk to the internal hard disk of TVX-HD and also Copy the contents within the internal hard disk of TVX-HD.

TVX-HD internal HDD < -- > internal HDD,  
 TVX-HD internal HDD < -- > Network DISK)

TVX-HD internal HDD < -- > external USB DISK (except nonstandard devices.)

- 1 Select the folder containing source files. (Currently, don't support folder copying)
- 2 Press Function key and select FILE SELECT icon.

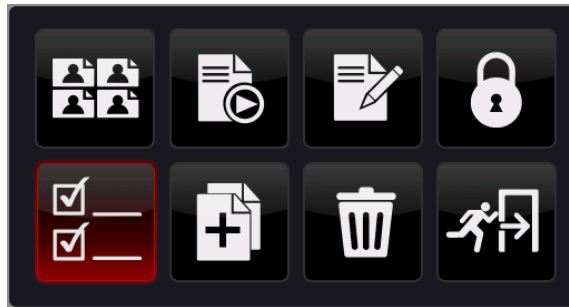

- 3 Select source file by using Up/Down key and OK button. Do not change to another folder in this mode. If files are selected, selected files are checked.

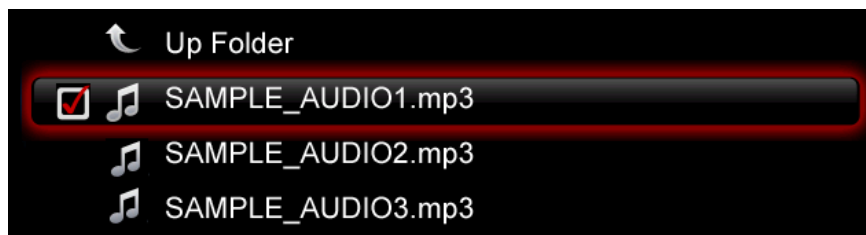

- 4 After selecting the file, press the Function key again and then select the COPY icon (  ). To cancel copying, press the Function key again and then press cancel icon.

- 5 In case of paste mode, you can use arrow keys, so that you can change the target folder. Navigate to the

folder where you want to copy, and press the Function key again then select the PASTE icon (  ).

- 6 You will see progress pop up after pressing PASTE icon as shown below

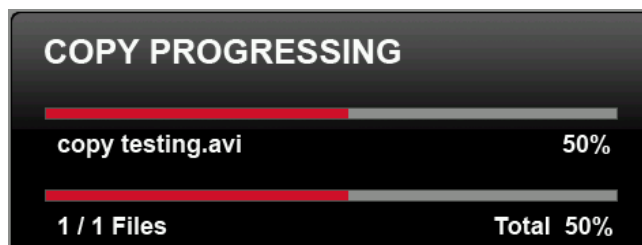

### 7.2.4 Folder Security

TVX-HD supports folder protection by assigning a password to the folder.

- 1 Select the folder that you want to password protect.
- 2 Press the Function button on your remote control.
- 3 Select the Set Password icon to set up the password.

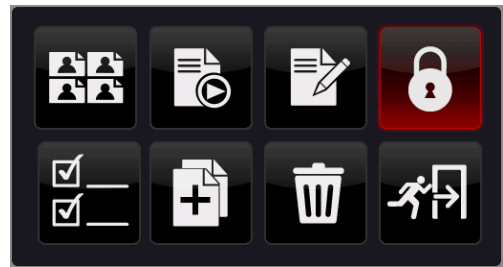

- 4 Press a 1~8 digit number from the Numeric key on the remote ( Ex: 1234). Press the OK button to complete set up.  
Perform the SETUP-SYSTEM-Load default settings to clear the password if the Admin Password is lost.

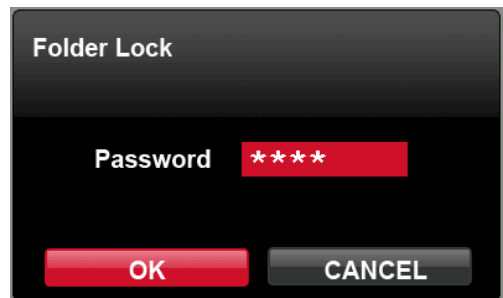

<< Notice >>

- The Set password and Remove password icons will be activated when a password is assigned to the folder.

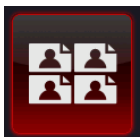

Toggle file list type



Add Playlist



Edit Playlist



Set password



Remove password

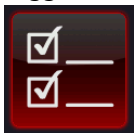

File select



File copy



File Paste



File delete



Cancel/Exit

- If you insert a wrong password, TVX-HD automatically goes to the file-selecting page.
- Perform the SETUP-SYSTEM-Load default settings if Admin Password is lost
- The password should consist of numbers only.
- You cannot delete a folder protected by a password with the delete key. Remove the password first.

## 8 Using Network

### 8.1 Using UPnP

< When connecting the computer directly to the TVX-HD >

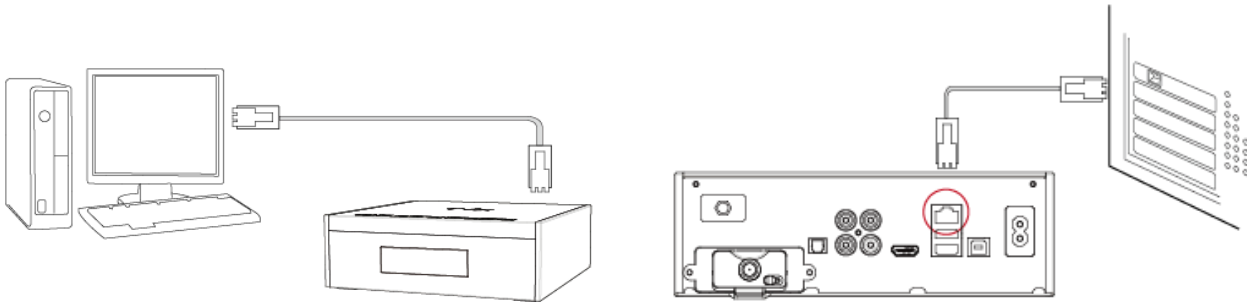

Connect the LAN cable to the LAN port of both the TVX-HD and the PC.

**TIPS**

In this case, you generally use a LAN cross cable type.  
If the computer's LAN card was connected to an Internet line, you can install an additional LAN card to your PC and connect that LAN card to the TVX-HD.

< When connecting with IP Router or Hub >

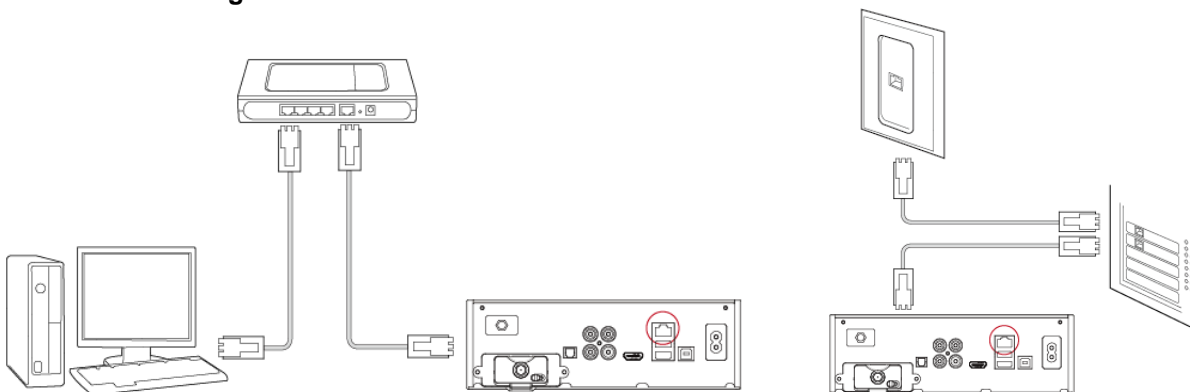

Connect the LAN cable to the LAN port for an IP Router or Hub.

**TIPS**

In this case, you generally have to use Direct LAN Cable type.

The UPnP allows you to connect to network easily with uPnP support, and it does not require an IP address. You can immediately playback uPnP connected files (even full HD files) on wired/wireless network environment.

With Samba Server technology support, it can be used as a network storage device using a window explorer for PC users, and it can also be used like a computer hard disk by specifying the shared folder between users in the same network as a network drive.

Netshare program allows you can play the TP or DVD jukebox without stutter easily. We recommend sharing files using the NTFS file system. The FAT32 file system does not contain enough information to create a lasting file name, so TVX-HD doesn't load the file after changing the file name.

### 8.1.1 How to set up UPnP server to your PC

Although there are various UPnP servers for PC users, We would like to recommend you all to use XBMC UPnP server which is relatively easy to use and supports external subtitles.

**1** Download the latest XBMC Media Center for Window from XBMC homepage

at <http://xbmc.org/download/>

**2** Run the XBMC Media center Wizard. When you click 'NEXT', it installs automatically. Then, additional setup is not necessary.



**3** Choose the components you want to install. Press 'NEXT'.

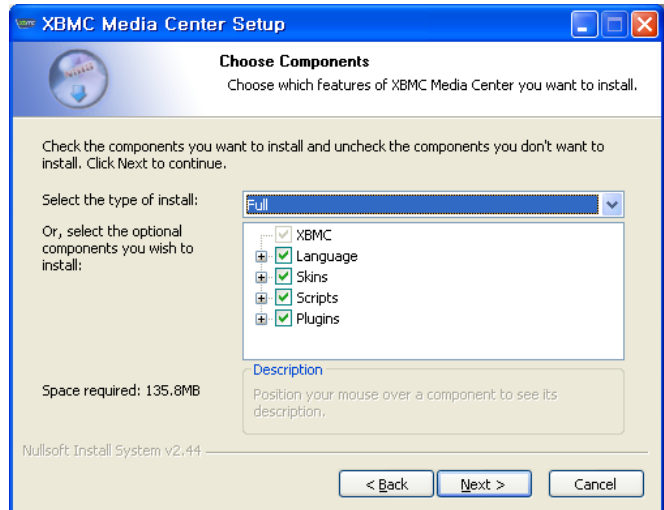

**4** XBMC Media Center has been installed on your computer..



### 8.1.2 How to set up XBMC server

Once the installation is done, XBMC program will start automatically. If it does not, you are requested to run it

by clicking XBMC icon(  ) on Desktop.

**1** The page is the main. You may change working environment at the Settings as your taste. What you should do to use UPnP function on TVX-HD is to set up the 'Settings'.



**2** Press 'NETWORK' icon on the settings.



**3** Click 'Enable UPnP server', and you will see 'Manage UPnP music shares', 'Manage UPnP Video shares', 'Manage UPnP Picture shares'

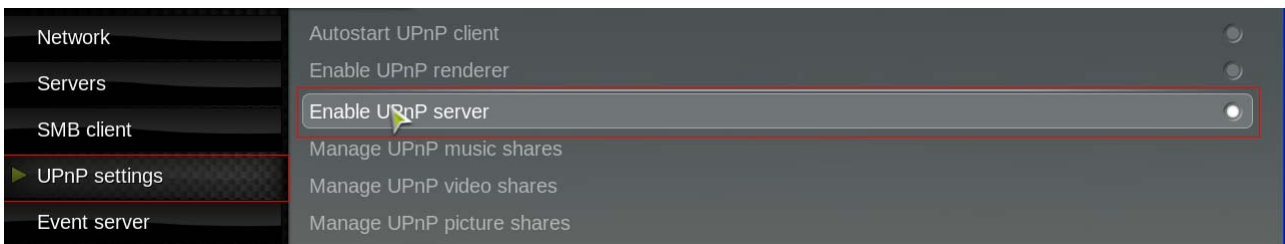

**4** After clicking 'UPnP Video shares', click 'Enter a name for this media source' tab to make the source name.

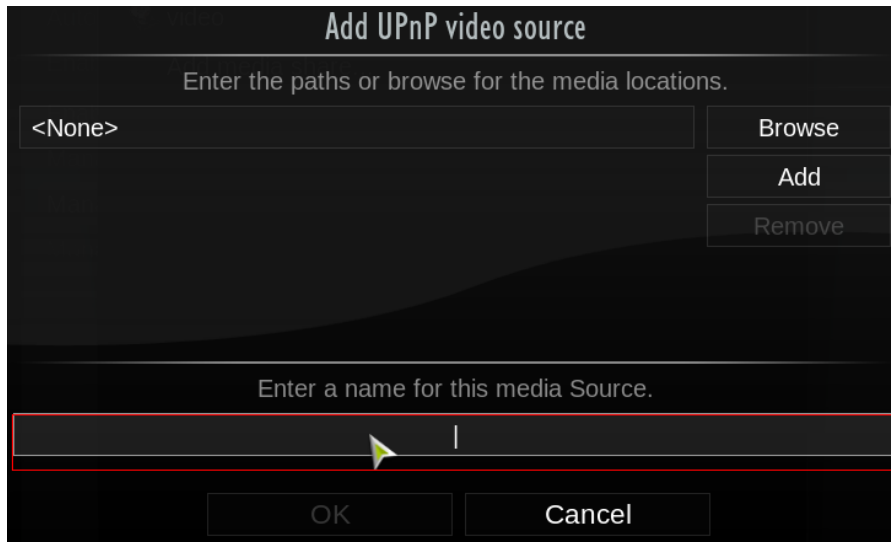

5 click the key pad and press 'Done' button.



6 To share the folder, press 'Browse' button.



**7** Press OK when you select the folder to share.

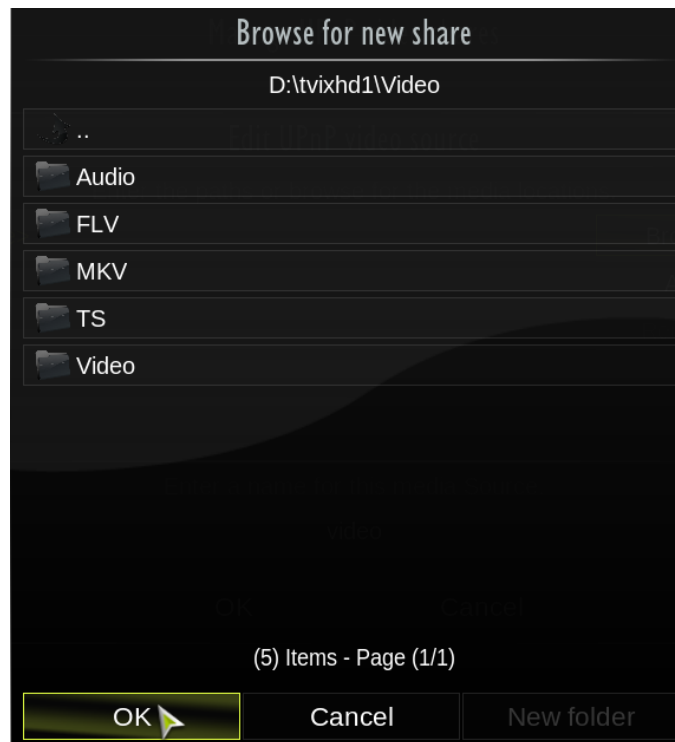

**8** You can see the path for the media location.

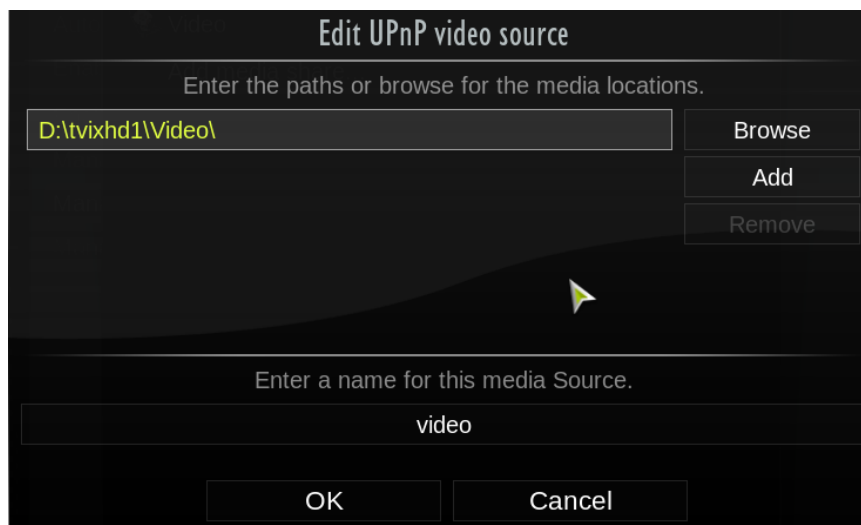

**9** In the same way, you can share the pictures and Music'.

◆ **Caution while using XBMC**

- Some file's extensions may be shown strangely on TVX-HD.
- Please change TP extension(recorded clip) to TS
- It may take time to read subtitle file(smi, srt, idx+sub) in the beginning of the file play
- If XBMC does not start automatically after re-start, please register XBMC on the START program on your PC



### 8.1.3 How to set up Wireless network

You can watch movies without a hard disk with wireless network support. Play videos, music, photos saved in your PC hard disk without having to transfer them to your TVX-HD.

You can play most of the HD video files (up to 18mbps) with 802.11n wireless Wi-Fi dongle (available as an option).

Connect the Wired network, and Upnp list will be displayed automatically.

Have your USB module attached to your TVX-HD, If your PC is connected with wire/ wireless AP router.

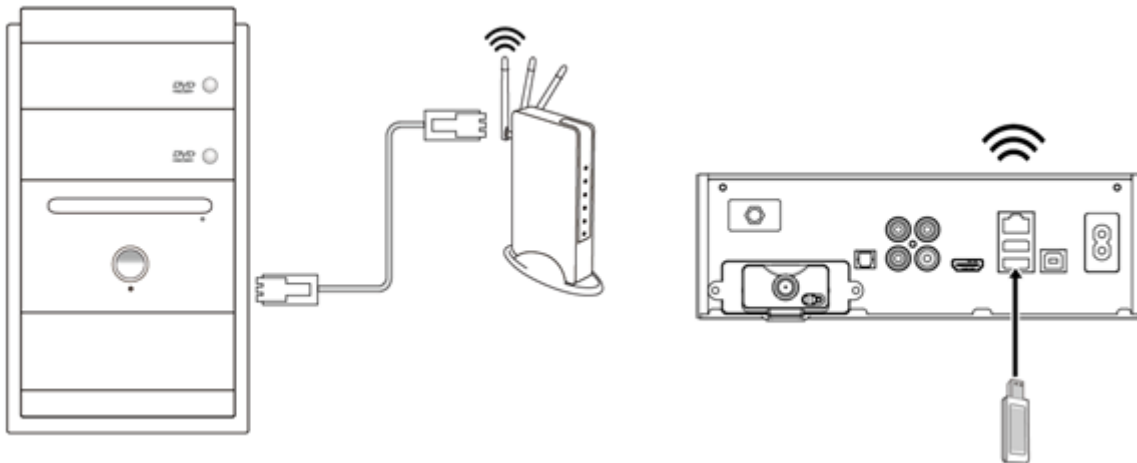

- 1 Press SETUP-NETWORK “Search Wi-Fi Network” for searching your AP or AP router.
- 2 After the interval of searching, you can see the following popup menu. Select the AP you want to connect with

A Lock icon means the AP uses security option.

**WEP key input : WEP 64-Bit/ WEP 128 key and ASCII and HEX key.**

WPA key input : ASCII only.

RADIUS (Remote Authentication Dial-In User Services) servers are not supported.

✳ **You have to configure the WEP setting of the AP using the AP’s instruction in advance.**

- 3 Insert the network key using virtual keyboard.

- 4 If you insert the correct network key, you should see well-formed TVX-HD Wi-Fi Network Info like following. The network key is Hexadecimal or ASCII.

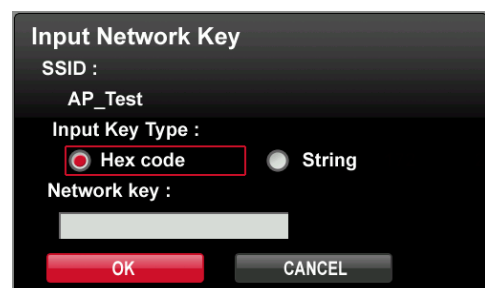
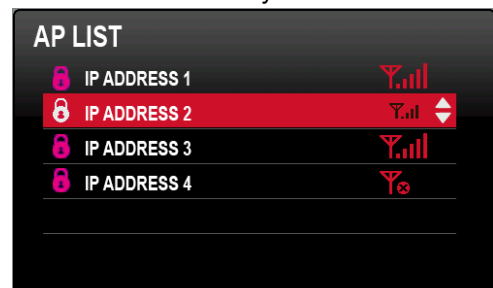

- 5 If the network key is wrong or the AP doesn’t work with DHCP setting, you would see some missing fields in TVX-HD Wi-Fi Network Info POP UP. Those fields which you might always see are TVX-HD IP and DNS.

- 6 If you still have problems after entering the correct key, please recheck your AP settings or reconnect the USB port.

- 7 Network disk setting : This setting is same as the wired network setting.

- 8 If Wifi network doesn’t work, press SETUP-NETWORK- “Wi-Fi IP setting” and select DHCP or static IP again.

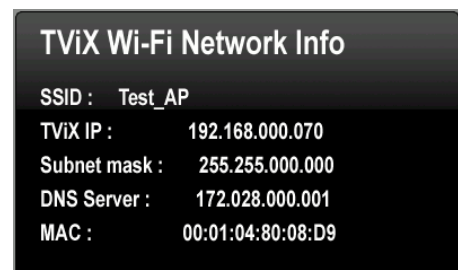

※ **Caution** ※

- 1 In connecting the Wireless USB to TVX-HD Device. The TVX-HD needs to be powered off initially and then Powered ON .Then on the Network setting Menu WIFI IP setting will be enabled.
- 2 For better Wi-Fi signals adjust the position of AP and USB module
- 3 If you play high definition files over Wi-Fi, you will see stuttering sometimes. Also, depending on the environment, you may experience stuttering when you play HD files.
- 4 If you use a USB Wi-Fi adapter with another USB device, it may not work properly.

\* After changing an AP setting, you must search the wireless network as in Step 2.

### 8.1.4 How to use UPnP

- 1 Select 'VIDEO' mode on the main at the main page



- 2 Press 'Left' button and then 'Right' button of the remote, then it moves to (UPnP) device. To see UPnP device, press 'OK' button on the remote.

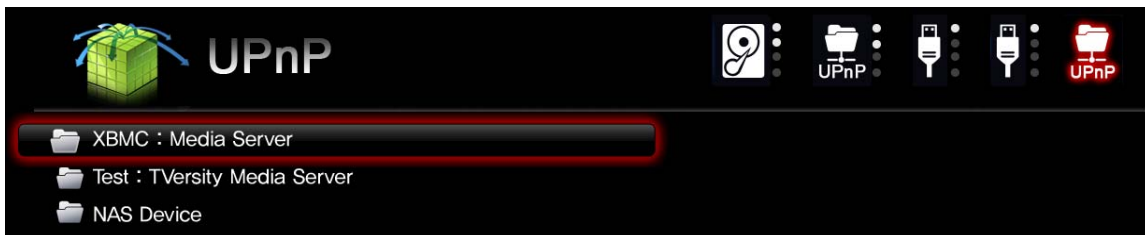

- 3 If you select one of them, you can see the contents that you set up on XBMC server. If you select 'Video files', you can see medial files that are in the PC or network device.

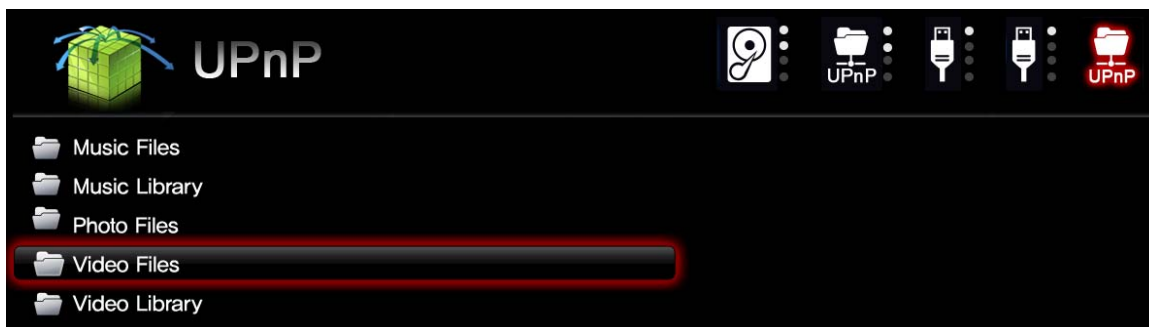

- 4 If you select a file that you want to play, it will be played like you do with the HDD inside.

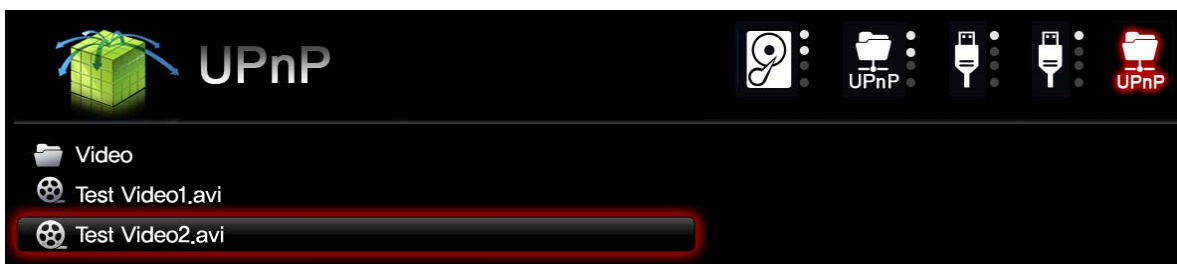

\*\* Some file's extensions may be shown strangely or not shown by network servers.

## 8.2 Using NetShare

### 8.2.1 TVX-HD NetShare Installation

Netshare program allows you can play the TP or DVD jukebox without stutter easily. We recommend sharing files using the NTFS file system. The FAT32 file system does not contain enough information to create a lasting file name, so TVX-HD doesn't load the file after changing the file name.

- 1 Most likely there will be an updated NetShare version on our web site. You may download and install using the latest TVX-HD Netshare installer or install TVX-HD Netshare from the enclosed TVX-HD CD.



- 2 Run TVX-HD Netshare installer and follow the on-screen prompts to install software.
- 3 The "Choose Destination Location" window will appear. Click on "Next" if you want to install the Net Share in the default directory. Otherwise, you can choose a different directory by clicking on "Browse".

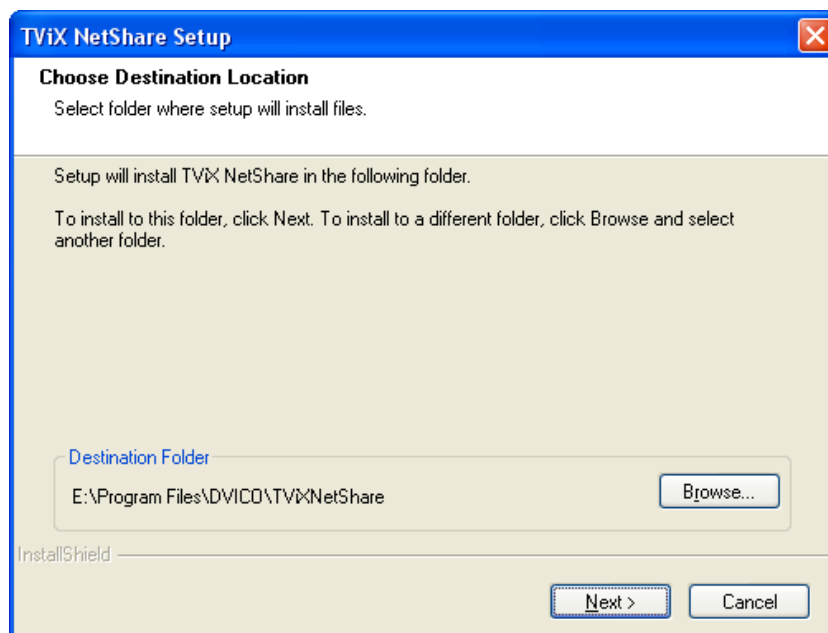

**4** Please select the location where you would like to share the folder. You may click the browser to find a shared folder.

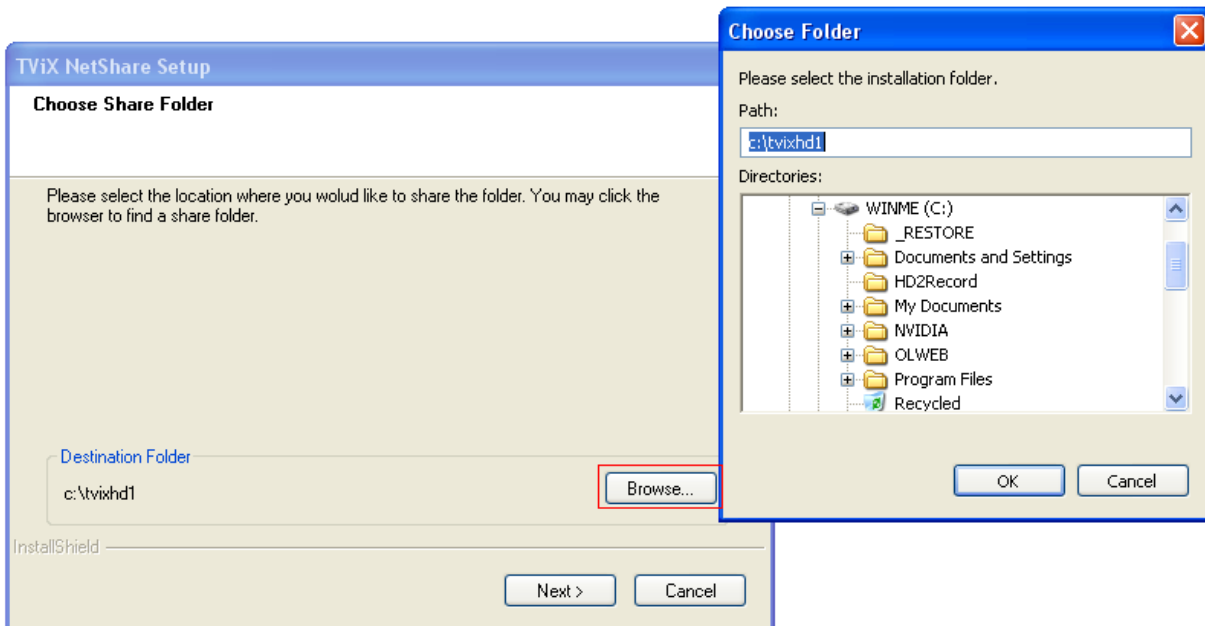

We recommend sharing files using the NTFS file system.

**5** The “Setup status” window will appear.

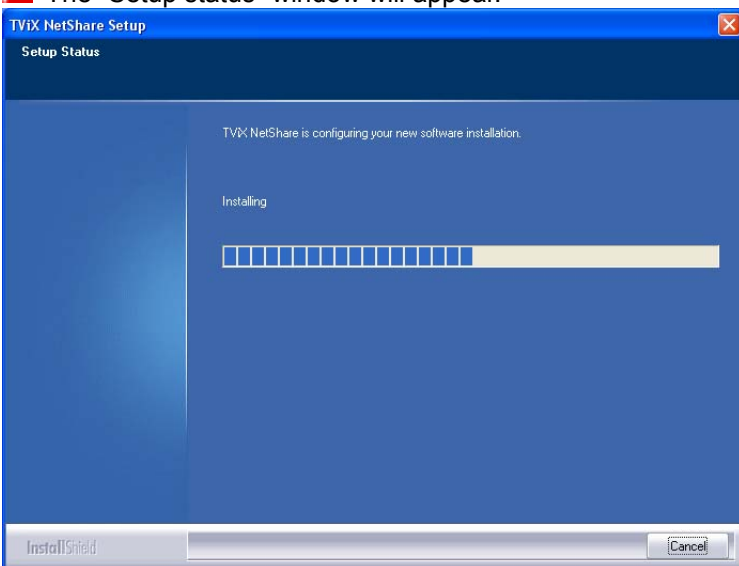

**6** Press YES button if you want to run the TVX-HD Net Share automatically.

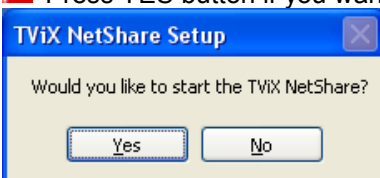

**7** By clicking the Finish button, the software installation is done.

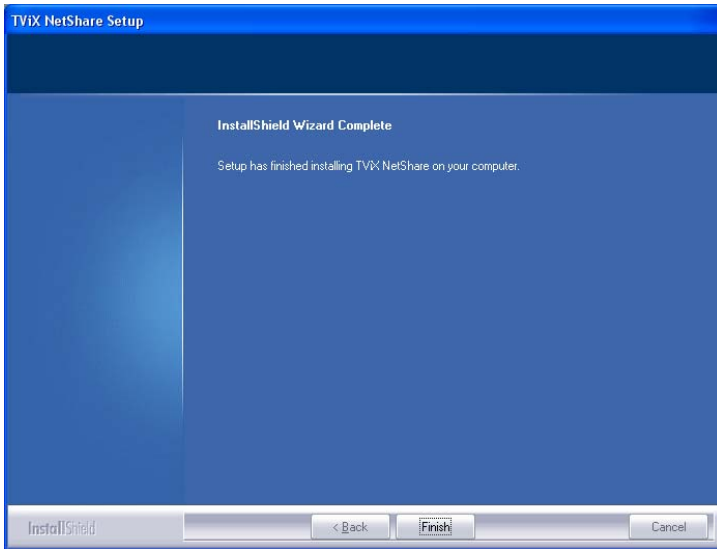

8 Press “**Unblock**” for the Windows Security Alert.



## 8.2.2 Using TVX-HD NetShare

**1** Click Start, point to Program->DVICO->TVX-HD NetShare.

If TVX-HD Netshare is already running, you don't need to run this program again.

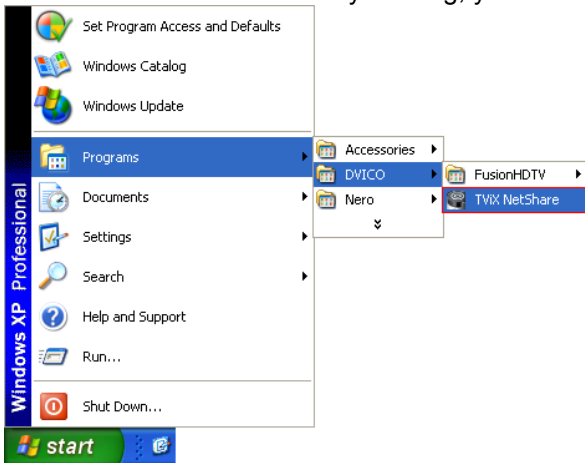

**2** After starting the Net Share program, you can see the NetShare icon in the tray..

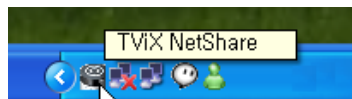
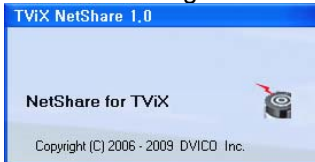

**3** Start the setting by right clicking the NetShare tray icon at the lower-right hand corner of the screen.

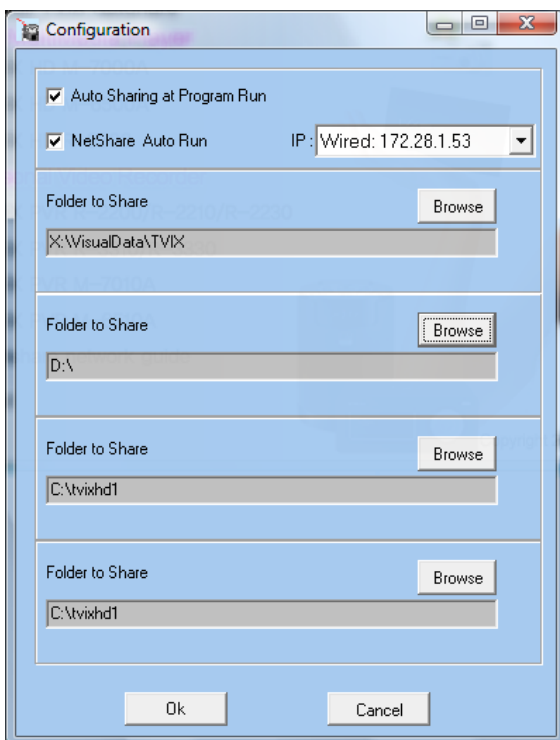
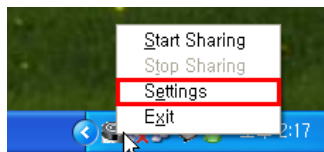
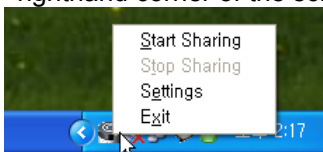

- Start Sharing : Used to start the sharing
- Stop Sharing : Used to stop the sharing
- Settings : Used to set the share folder
- Exit

**4** After running the NetShare software application on the system, right click on the NetShare icon and select Settings.

- NetShare AutoRun : used to autorun when Windows re-starts.
- Auto Sharing at Program Run : used to start sharing automatically at program startup.
- Folder to Share : used to Select the folder and Files from the drives shared by Clicking on the Browse icon. In case of FAT32 file system, TVX-HD doesn't load the file after changing the file name.

### 8.2.3 Sharing of Multi folders

1 After running the Netshare software Application, right click on the Netshare ICON.

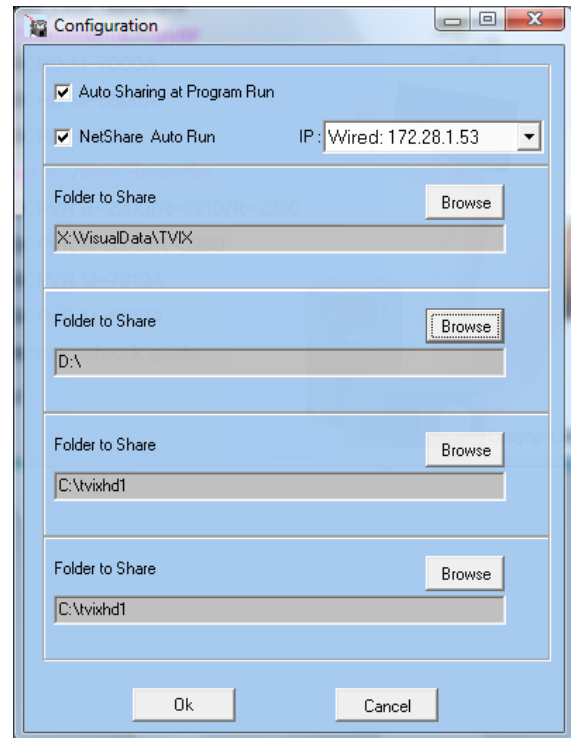
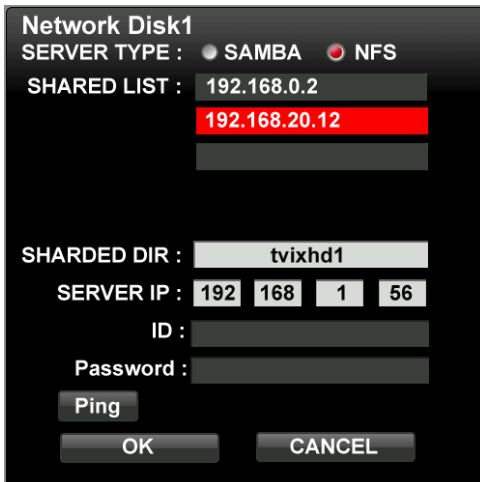

2 Click on Browse, Corresponding to Folder 1 to Share.

3 Select the Appropriate folder, Containing Media Files from desired Drive and Click OK.

4 Again Click on Browse, Corresponding to Folder 2~ Folder4 to Share.

5 Select the Appropriate folder, Containing Media Files from the desired drive and Click OK.

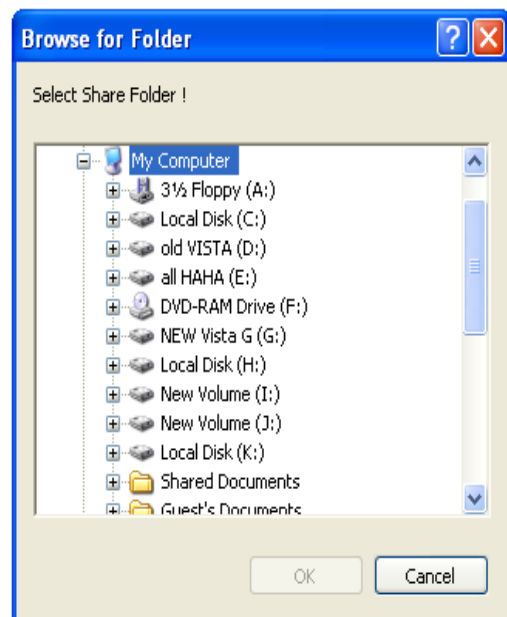

#### CAUTION

If you press the stop sharing when the network is connected, you can see "TVX-HD Sharing closed." On the setting feature.

You must again Press the "start sharing" on the tray window for network Sharing to start.

## 8.3 SAMBA Client and SAMBA Server

### 8.3.1 Set Network Configurations Under Windows XP (SAMBA mode)

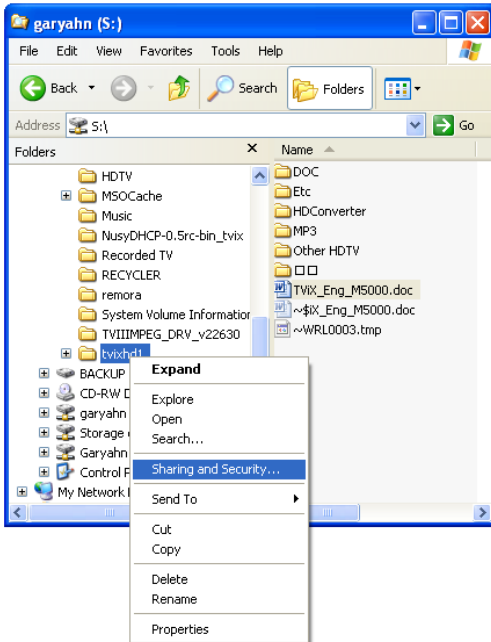

**1** Select the folder you want to share. Right-click that folder and click 'Sharing and Security' in the popup menu.

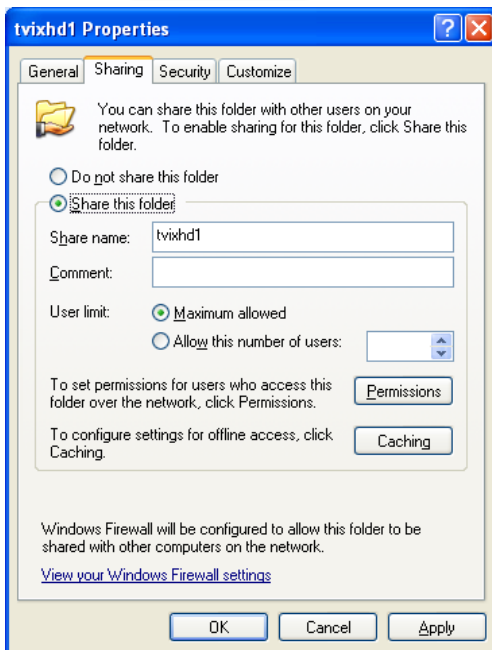

**2** Check 'Share this folder' on the network and type in the share name 'TVX-HDhd1 (this is the only available one at the moment)'.

**3** Use 'Everyone' if 'Everyone' is displayed, otherwise you don't have to change anything. Also, add 'Everyone' to the security tab.

**4** After that, the shared folder will be displayed like the

following picture.  **TVIXHD1**

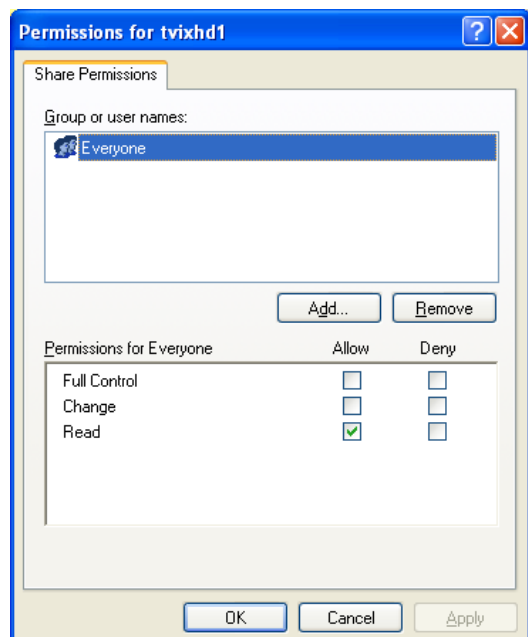



- 5 Move to 'Settings' > 'Control Panel' > 'Administrative Tools' > 'Computer Management' > 'Local Users and Groups' > 'Users', and double click 'Guest'.



**CAUTION**

This is for Windows XP Professional. Windows XP Home users cannot see this window. If you cannot find 'Administrative Tools' in the Control Panel, click "Switch to classic view" in the upper-left corner of the screen.

- 6 Uncheck 'Account is disabled'

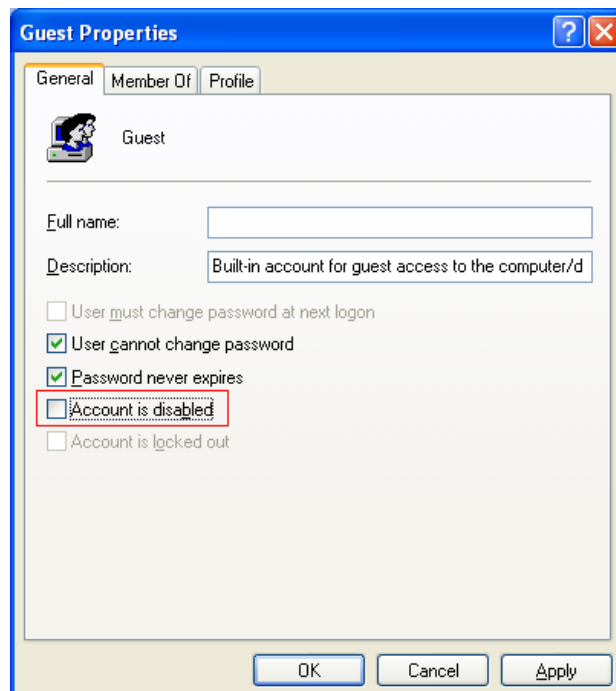

7 'GUEST' must be shown as the following image (a red X mark should not be shown on 'Guest').

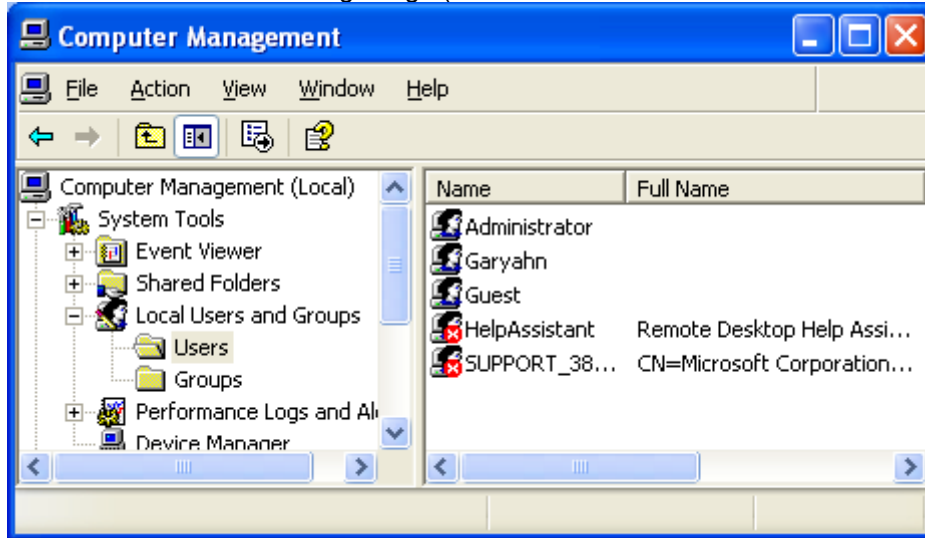

8 Move to 'Control Panel' > 'Network connections', and select 'Properties' s by right click on the mouse.

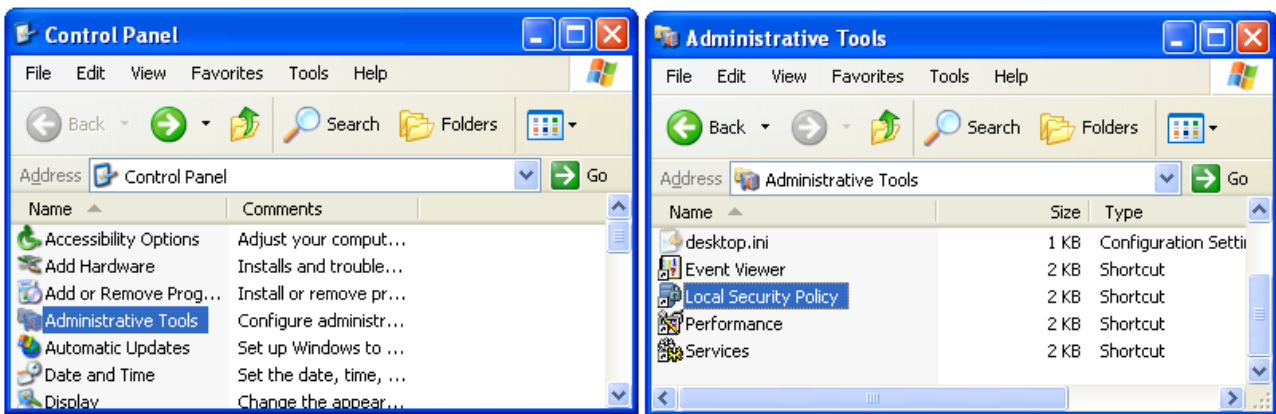

9 Remove "Guest" from the 'User Rights Assignment' > 'Deny access to this computer from the network' option.

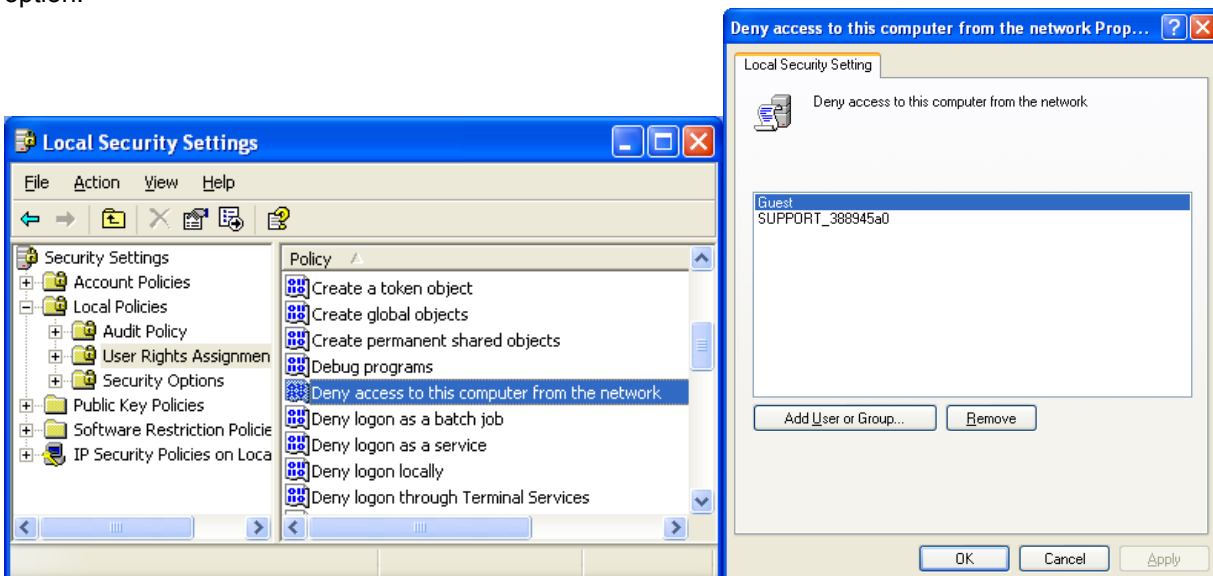

10) Move to 'Access this computer from the network', and then select 'Properties' by right clicking the mouse or double clicking it.

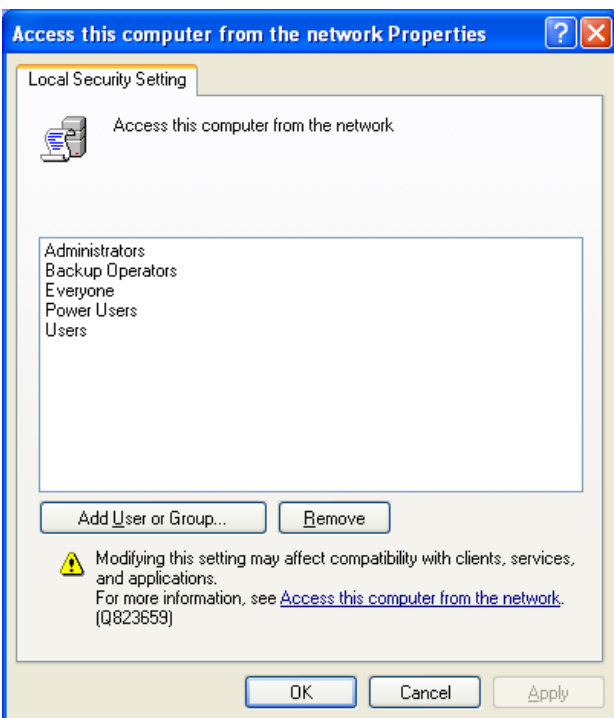
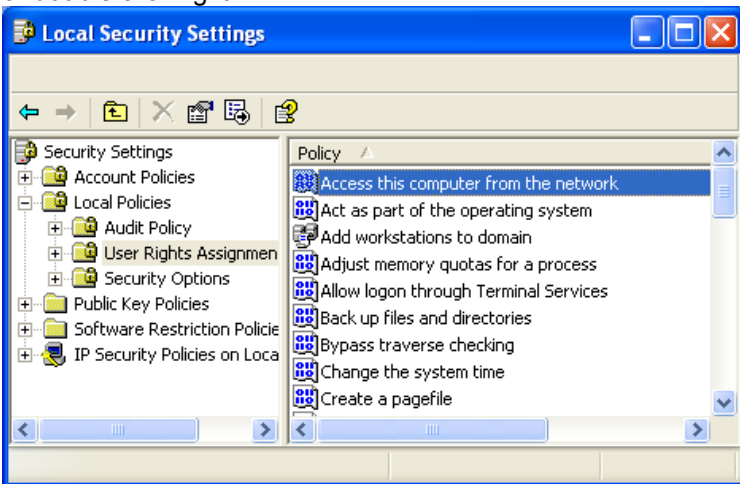

11) Click on 'Add User or Group'

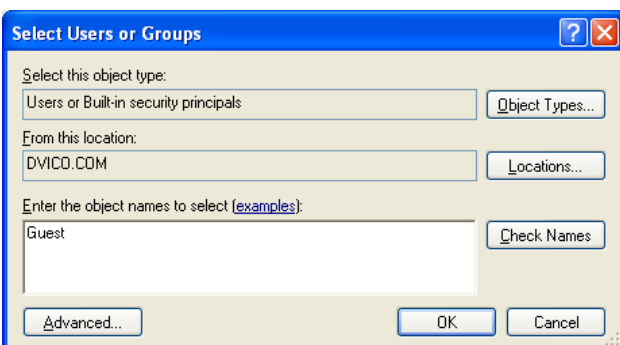

12) Type in "Guest" and then click on "OK" button.

13) Press OK, and Guest will be registered.

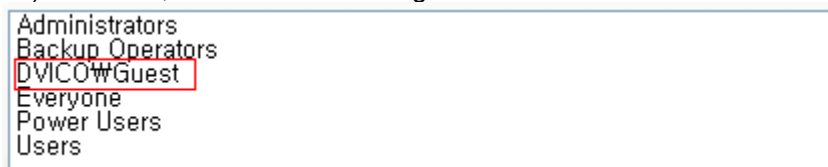

## < When connecting Computer to TVX-HD directly >

In this case, you have to use Cross LAN cable type generally.

If the computer's LAN card was connected to Internet line, you can mount additional LAN card to your PC and connect that additional LAN card to TVX-HD.

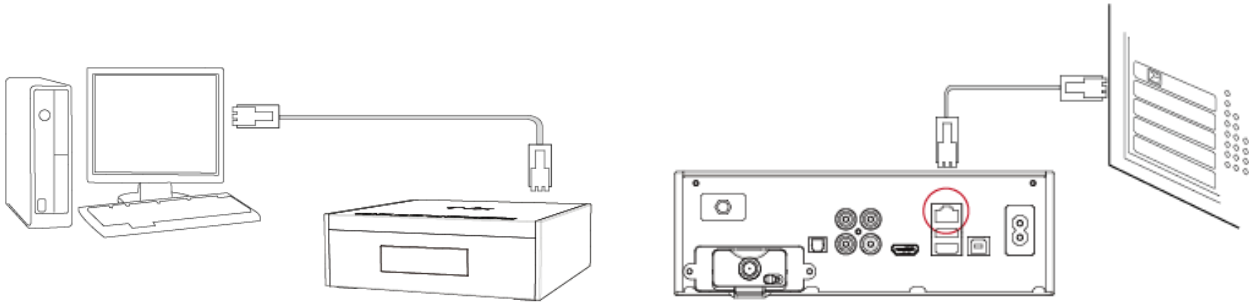

**1** Move to 'Control Panel' > 'Network connections', and select 'Properties' by right click on the mouse.

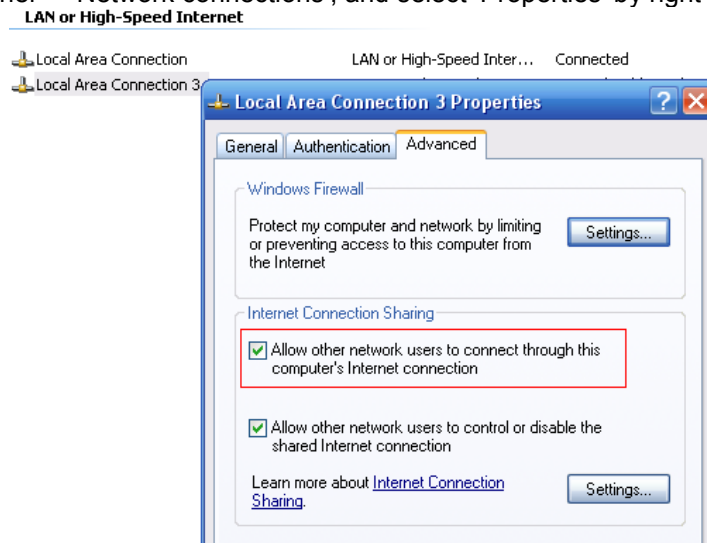

**2** When Windows 2000 or XP, Check "Allow other network users to connect through this computer's internet connection"

**3** Double click 'TCP/IP->LAN card' that you want to use on your computer. You must select the additional LAN card.

Check 'Specify an IP address', and write 'IP address' & 'Subnet mask' that you want to use.

Ex) IP address : 192.168.0.1 Subnet mask : 255.255.255.0

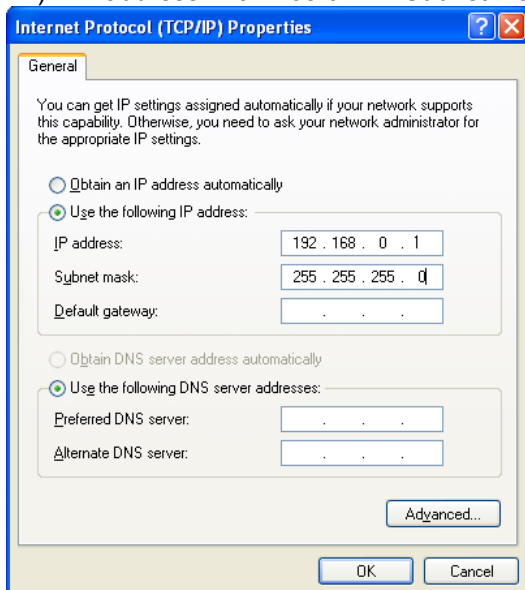

## < When connecting with IP Router or Hub >

If you have already been assigned dynamic IP address from a DHCP Server or IP Router in your local area network, then no need to write a static IP address. Then obtain the automatically assigned IP address or write an IP address & Subnet mask that the DHCP Server or the IP Router provides.

Select 'Control Panel' > 'Network Connections', and select 'Status' properties by right clicking the mouse. After clicking the Support tab, you should see an IP Address. (ex: 192.168.1.127)

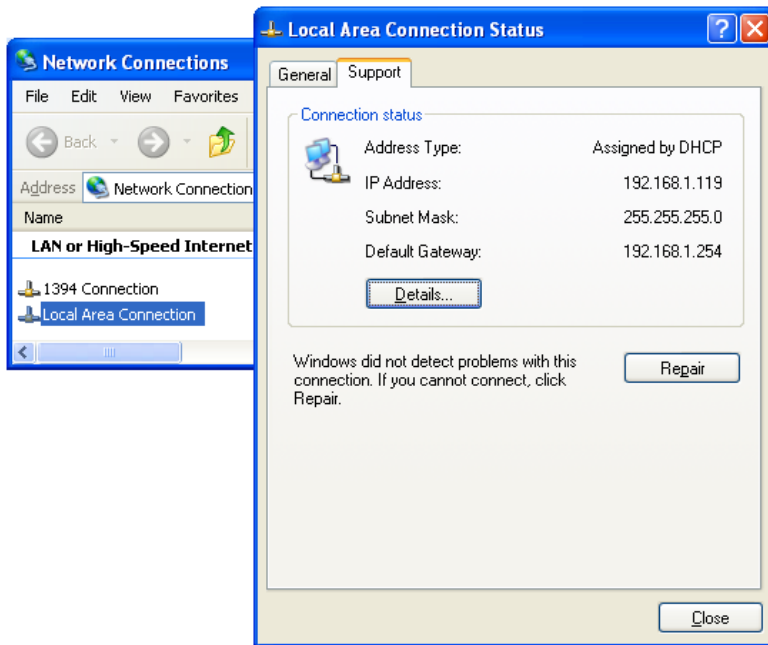

## < Disable Windows Firewall >

- 1 Move to 'Control Panel' > 'Network Connections', and select 'Properties' by right clicking on the mouse. Click on the 'Advanced' tab. Disable 'Internet Connection Firewall'.
- 2 If you use service pack 2, click on 'Settings' at 'Windows Firewall'.
- 3 Check 'Off' and then click 'OK'

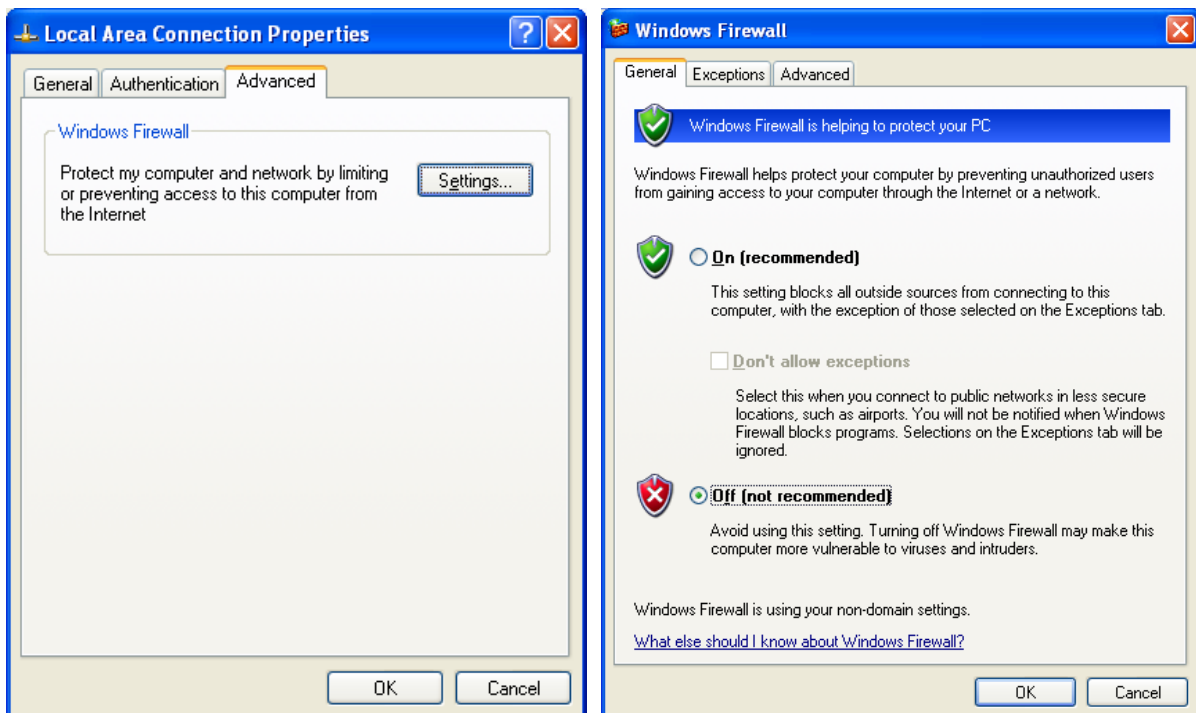

### 8.3.2 Setting Static IP Network Configurations in TVX-HD

**1** Press [SETUP] button on the remote. setup screen will be displayed. On that Set UP screen, select Network setting→Network disk and type the IP address in the Server IP. (ex: 172.28.1.70)  
The default is DHCP and if you want to set Static IP, you can select and change Static IP on the IP setting. If you have used the DHCP you don't need to assign the IP address because it will be assigned automatically.

**2** If you cannot access via LAN with DHCP setting, we recommend to use the Static IP setting.

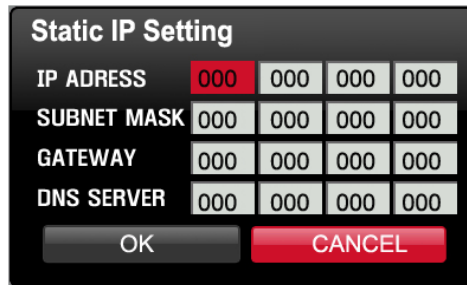
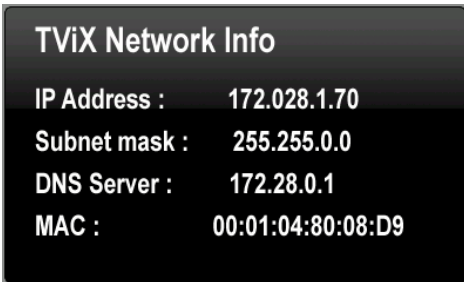

**3** Select 'Control Panel > 'Network Connections', and select 'Status' properties by right clicking the mouse. After clicking the Support tab, press details, and you can see the Network connection details. Copy the Subnet Mask, default gateway, and DNS server addresses from the PC listing. You must write a different IP address (ex: 172.28.1.70 → 172.28.1.168) wherethe first three numbers in the TVX-HD's IP address are the same as the PC's and the fourth number is different.

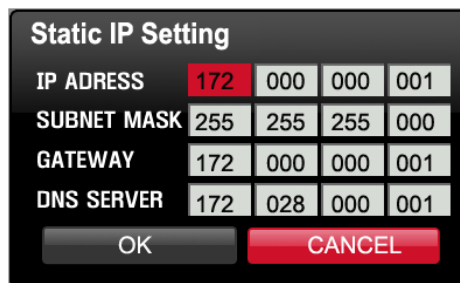
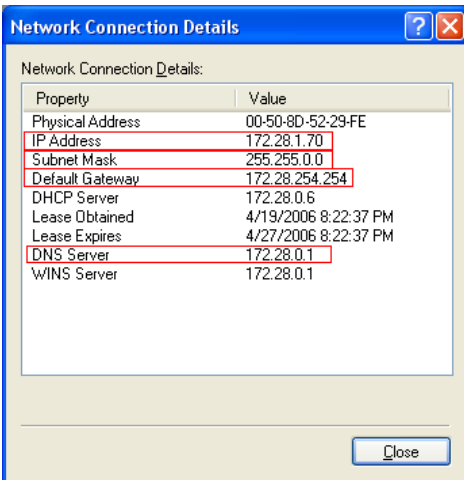

**4** When the setting is successfully finished, you will be able to see the 4 PC Tray Icons. Network Disk is supported up to 4 PC Tray system. You can see the partition on the network icon like below image.

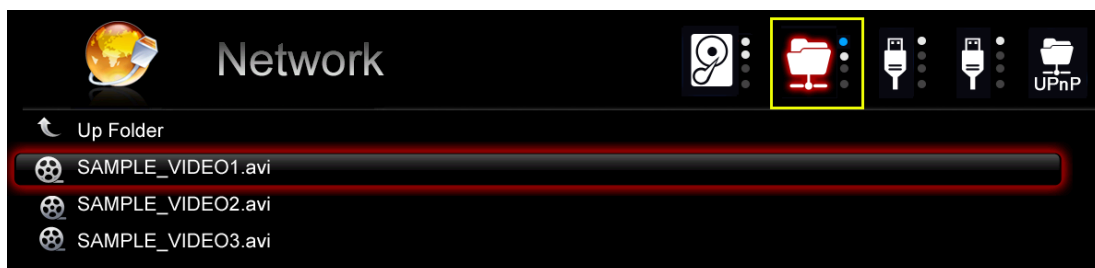

**5** You may check for detailed usage at the TVX-HD website.

### 8.3.3 Using SAMBA Server

Using SAMBA Server, You can copy/move/delete files from PC to TVX-HD via LAN. SAMBA is supports internal hard disk only.

**1** Press the Network Info on the SETUP-NETWORK. And note down the TVX-HD IP

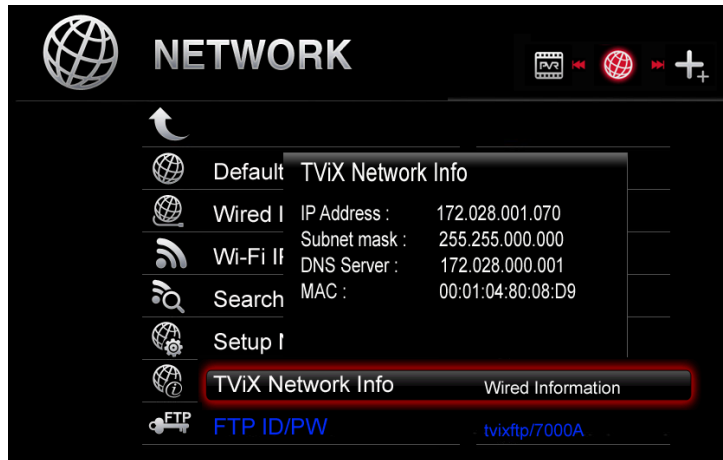

**2** Click on Internet explorer, and then type the TVX-HD IP as shown [172.28.1.70](http://172.28.1.70). Tvixhd1 network driver will be shown.

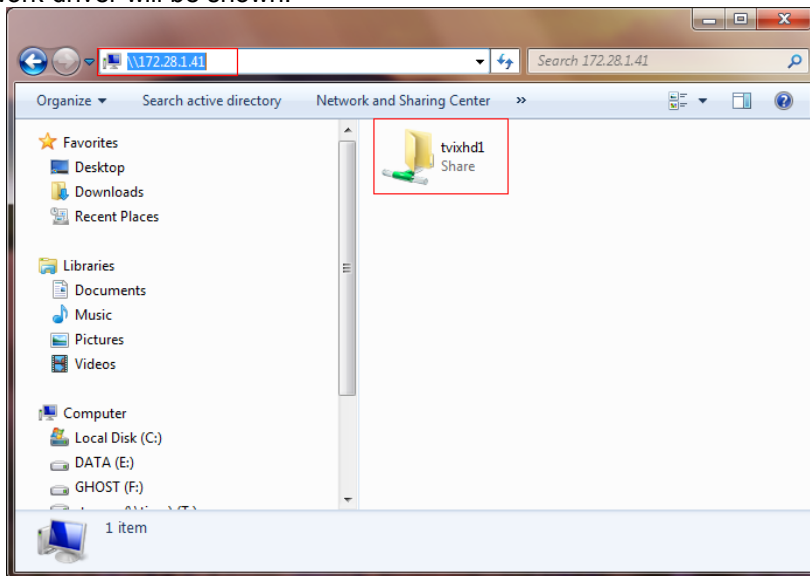

**3** Hard disk content are displayed on the PC. You can copy/ move/ delete files in this directory. After making the Network drive with this TVX-HD drive, you can play the movie from TVX-HD while downloading or uploading files.

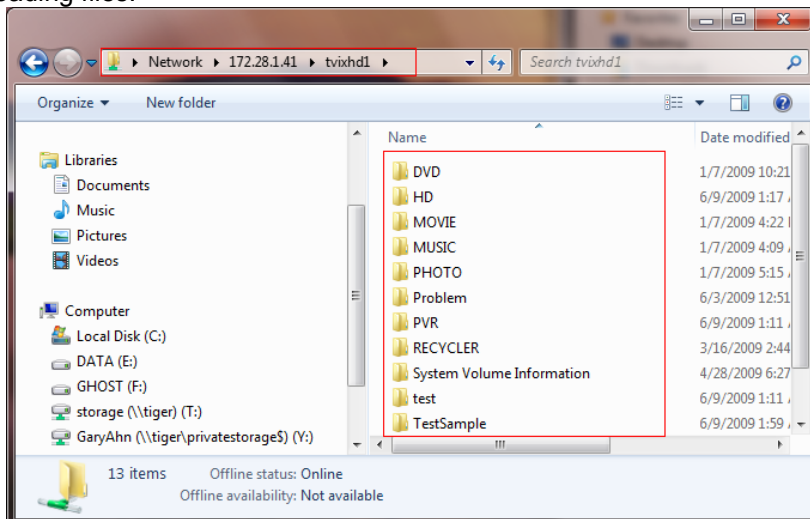



## 9 Firmware Upgrade

### Firmware Version Check.

- 1 Connect the TVX-HD to your TV and then turn on the TVX-HD.
- 2 Press the SETUP button on the top panel and the setup screen will be displayed.
- 3 Check the latest firmware version of TVX-HD Homepage

\*\*\* You'll be notified of any firmware updates or news if you fill out the customer registration form at TVX-HD homepage.

### Downloading the Firmware.

- 1 Download the latest firmware from TVX-HD Homepage to your PC.
- 2 Connect the TVX-HD to your PC with a USB and then turn it on.
- 3 Your system will recognize the TVX-HD as an external hard drive.
- 4 Copy the latest firmware files into the root of the TVX-HD hard drive or USB memory device.
- 5 Turn off the TVX-HD and bring it to your TV for firmware upgrading.

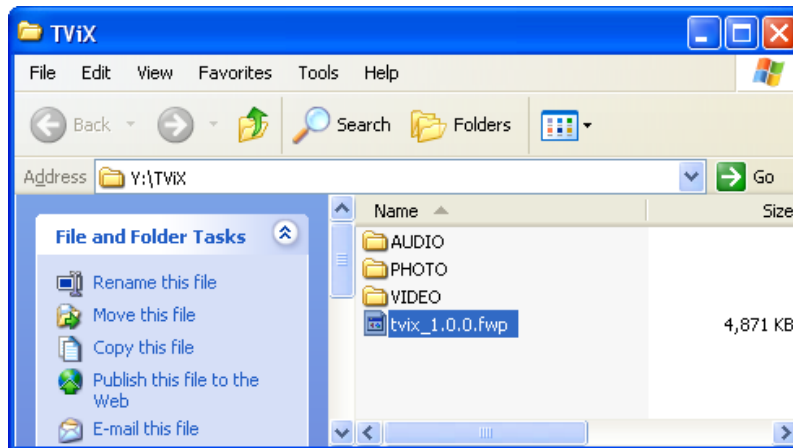

### How to Upgrade the Firmware

- 1 Connect the TVX-HD to your TV
- 2 Select the copied firmware file (ex: TVX-HD1.0.0.fwp) and press OK on the remote to start upgrading.
- 3 The following screen will be displayed. Follow the instructions on the screen.

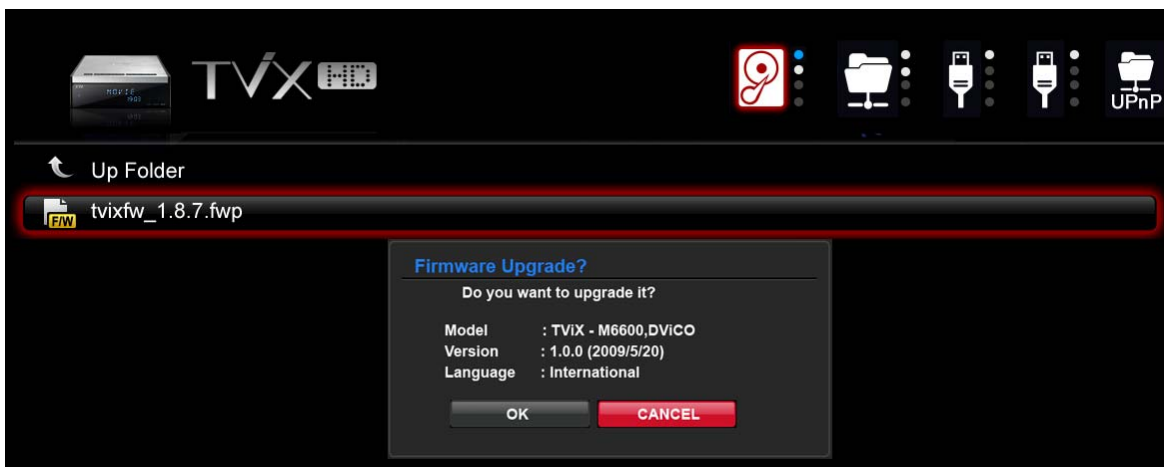

- 4 New firmware upgrade is in process (takes about 3 minute). When the upgrade is successfully finished, the TVX-HD will reboot automatically.

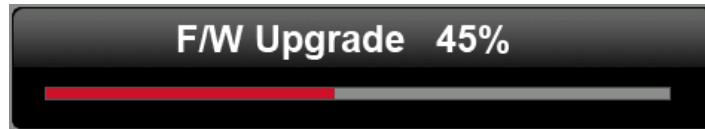

**< CAUTIONS: Safe Mode Upgrading >**

Even if the TVX-HD accidentally turns off during the firmware upgrade, the safe mode will enable the TVX-HD to be re-upgraded.

Please follow the steps below:

- 1 Connect the TVX-HD to your PC with a USB and then turn it on.
- 2 Copy the latest firmware files into the root of the TVX-HD hard drive or USB memory device
- 3 The Safe upgrade will check the firmware file of internal HDD in advance and then external USB host.
- 4 Press and hold the MENU button on the top panel and turn on the TVX-HD by using power button.

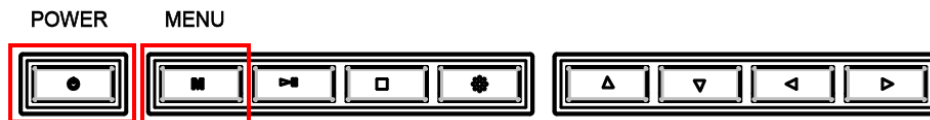

- 5 The VFD will show the seeking FW, such as SEEK FW.
- 6 Press OK on the control panel to start upgrading.
- 7 The VFD will show UPG when the new firmware upgrade is in process.
- 8 The TVX-HD will automatically reboot after the upgrade has been successfully finished.

## 10 Using USB Connection with a PC

TVX-HD uses a SATA HDD as its contents storage device and works just like an external USB 2.0 hard drive when you connect it to your PC.

The USB cable has a different shape on both ends. We use USB 2.0 "A" Plug (male) type to "B" Plug(male) type.

After connecting to your PC, turn on the power of the TVX-HD.

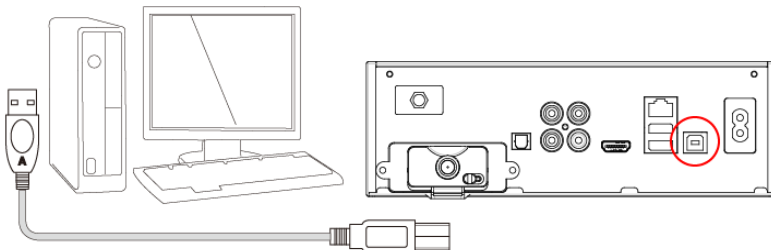

If you are a using Windows98SE user, you should download a USB storage driver from our web site before you connect your TVX-HD with your system. You do not need to install the driver under Windows ME/2000/XP

### 10.1 Making a Partition and Formatting the HDDs

- 1 Under Windows 2000 or above OS, you can make a partition and format the HDD using the Disk Manager utility.
- 2 Right click "My Computer" → Choose "manage" from the pop up menu and the "Computer Management" window will appear → choose "Disk Management" folder.
- 3 The disk list will appear on the right side of the "Computer Management" windows. Right click the TVX-HDD from the list, and from the pop up menu choose "make partition" to create partitions on the chosen disk.

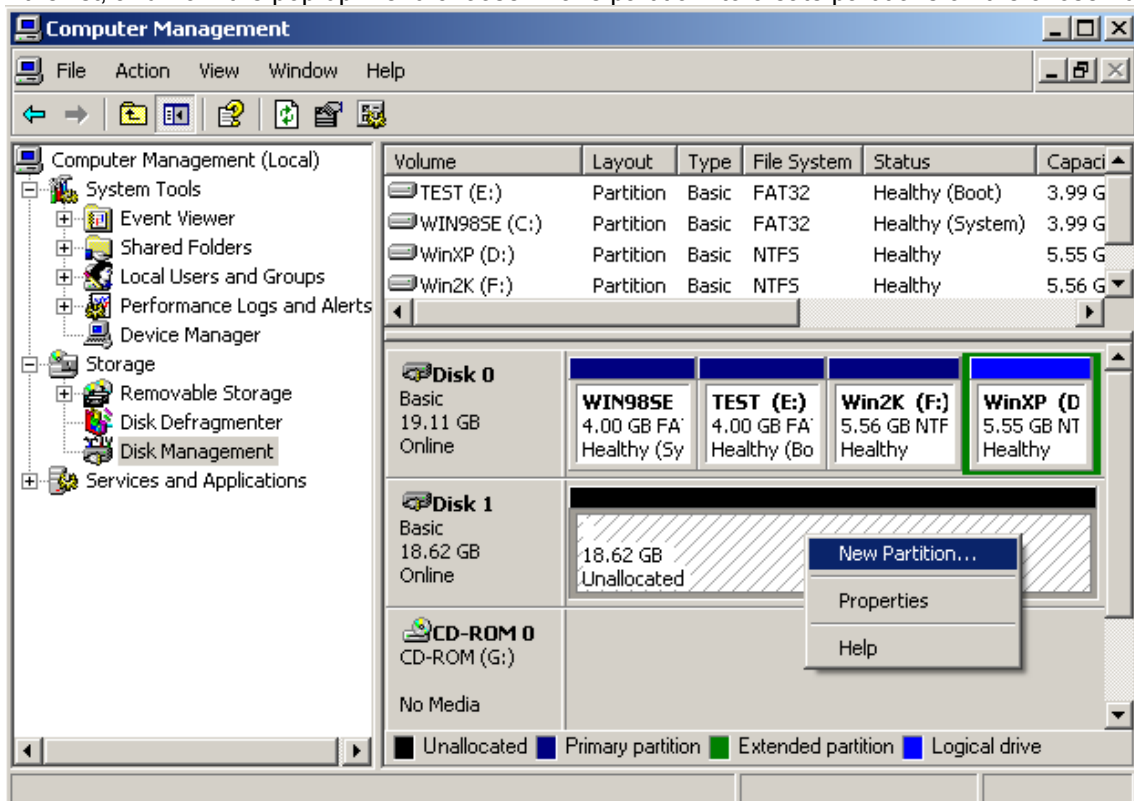

- 4 When the New Partition Wizard appears, press "Next>".

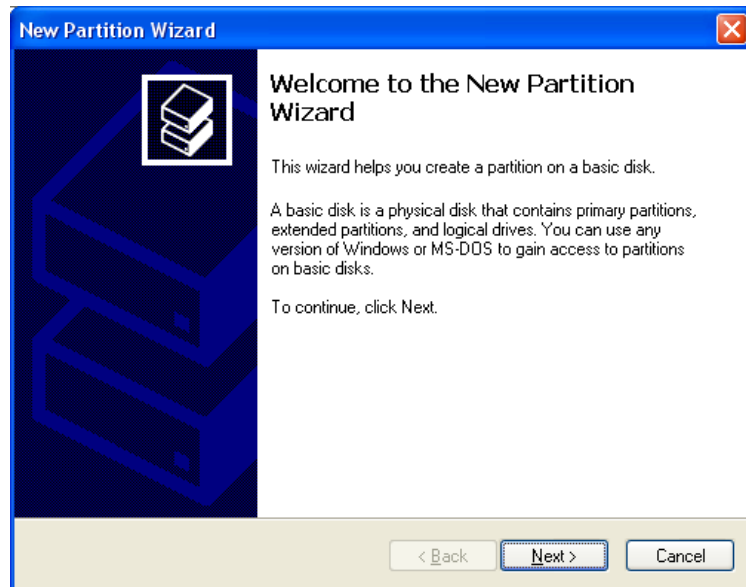

5 Choose the partition type and format the HDD. If you want several partitions, select Extended Partition.

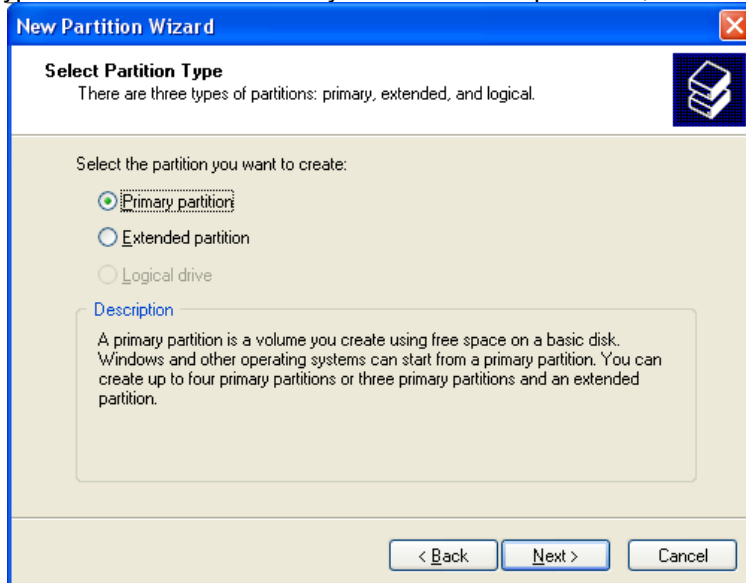

6 Select the partition size. If you want one partition, press "Next>". For FAT32, size is limited to 32000MB or under.

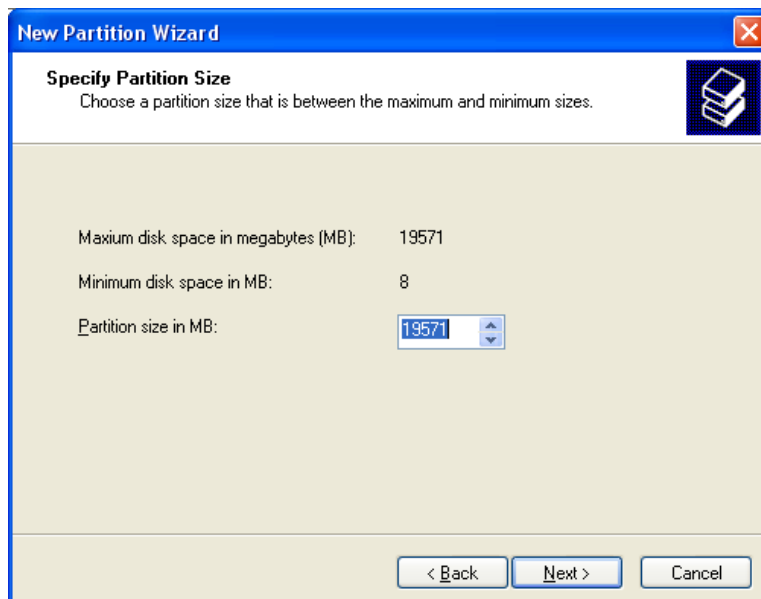

7 Select the Drive Letter. Then press the “Next>” button.

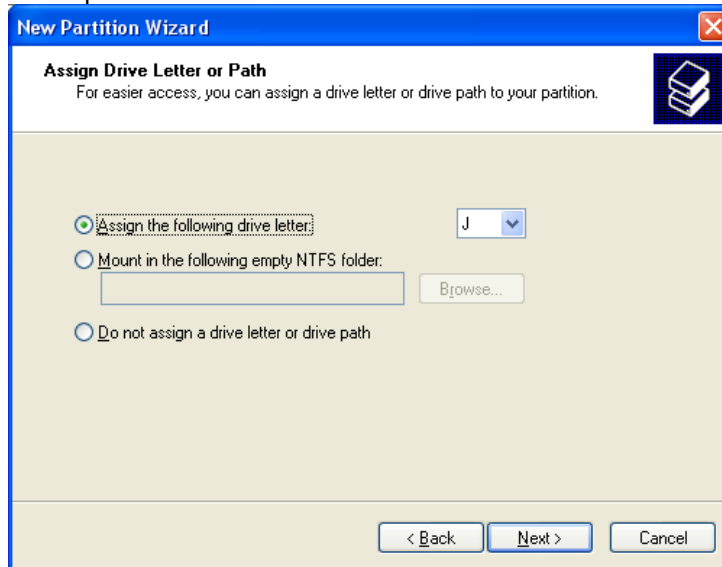

8 Select the partition Format. If you choose FAT32 file format on Windows 2000/XP, the drives maximum size will be limited to 32GBs. If you want to use a single drive letter of 32GBs or more, you have to format on Windows 98SE/ME. We don't recommend the FAT32 partition to record the DTV channel.

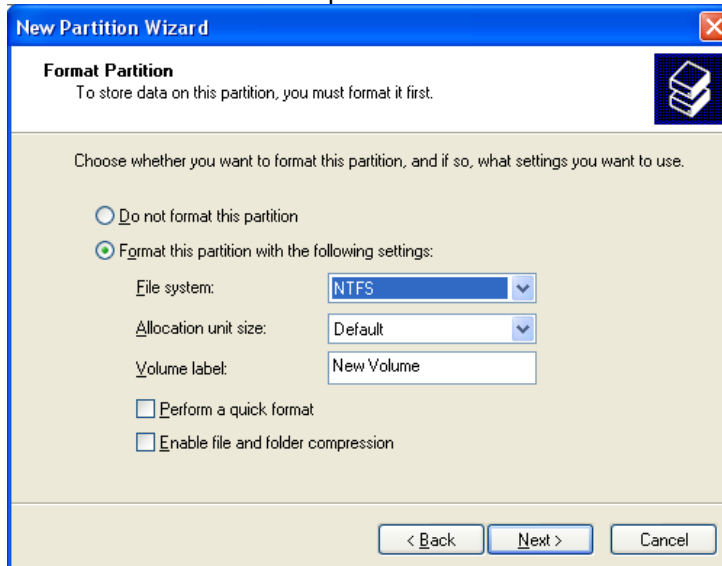

9 When completed, detailed information will appear as shown below. Click the “OK” button to finish.

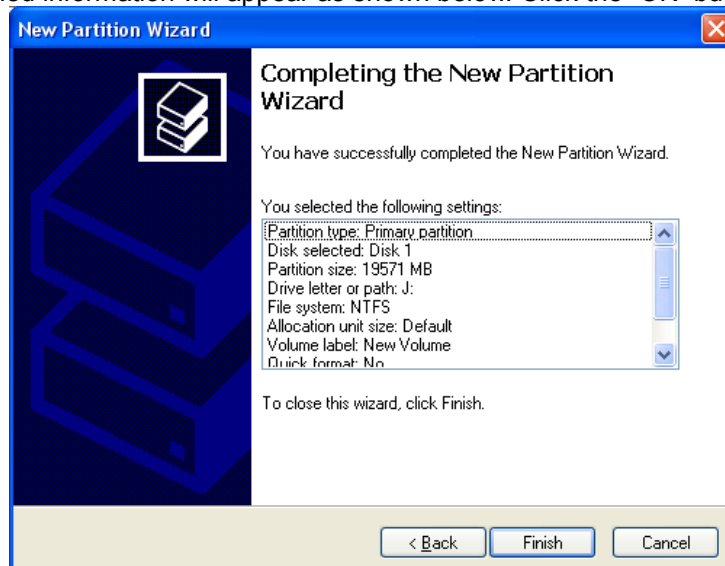

## 10.2 Unplug or Eject Hardware

- 1 On the windows tray,  double click the hot swap icon. The “Unplug or Eject Hardware” window will appear. Press the Stop button if you want to unplug the device.

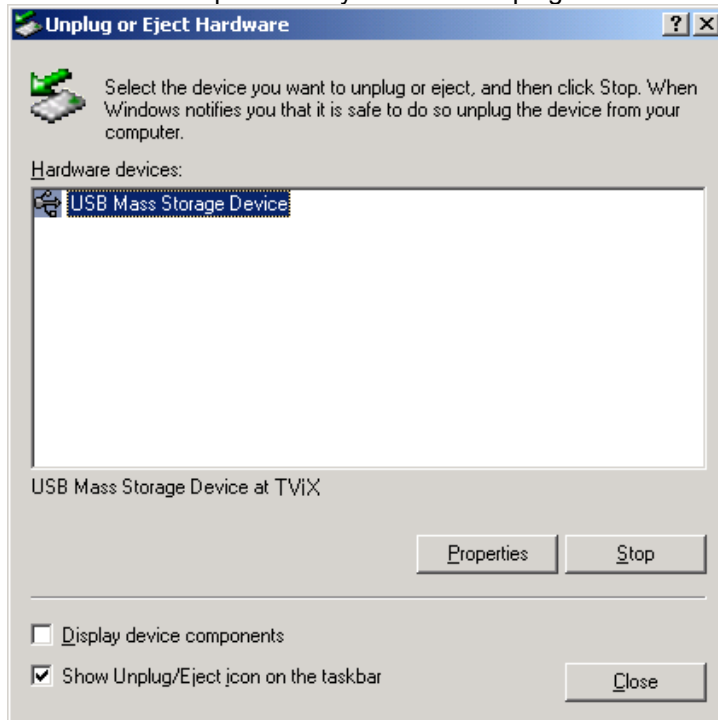

- 2 Press OK on “Stop a Hardware device” window.



- 3 Press OK and unplug the device.



Close TVX-HD folder or disk on My computer before unplugging the Hard disk.



If TVX-HD folder is open, unplugging it may not work properly.

## 11 Troubleshooting

**\*\* For detailed instructions, please refer to the latest pdf file on the TVX-HD Homepage or TVX-HD FAQ.**

Under no circumstances should you try to repair the system yourself, as this will invalidate the warranty. Do not open the system as there is a risk of electric shock. If a fault occurs, first check the points listed below before taking the system for repair.

<p>No Screen Display. Video Output not working.</p>	<ol style="list-style-type: none"> <li>1. Press the TVOUT button on TVX-HD remote to toggle between TV OUT settings.</li> <li>2. Check the TV-OUT settings and cable-type on the TVX-HD and ensure that it is consistent with the VIDEO-IN settings of the TV.</li> <li>3. Ensure that the Video Cable is securely connected to the TVX-HD and to the TV.</li> </ol>
<p>The TVX-HD does not respond to the Remote Control. Menu Items cannot be selected.</p>	<ol style="list-style-type: none"> <li>1. Reduce the distance between the Remote and the TVX-HD and try again.</li> <li>2. Replace remote batteries.</li> <li>3. Perform a Hardware factory Reset Procedure.</li> <li>4. Check for interference from other IR sources by trying to operate the TVX-HD with all other components turned off.</li> </ol>
<p>TVX-HD does not recognize the HDD.</p>	<ol style="list-style-type: none"> <li>1. Check the USB connection to the Hard Disk Drive(HDD).</li> <li>2. Check to ensure that the HDD has been correctly partitioned and formatted.</li> </ol>
<p>TVX-HD does not show subtitle.</p>	<p>Re-name the subtitle file the same as avi file name (except for file type extensions). TVX-HD can show the subtitle when the file name is same.</p>
<p>TVX-HD does not display the Network-shared Folder on your PC.</p>	<ol style="list-style-type: none"> <li>1. Check network connection between your PC and the TVX-HD.</li> <li>2. Reboot the TVX-HD and re-establish the connection.</li> <li>3. Depending on network environment, there may be a delay in searching for the network for up to about 10 minutes.</li> <li>4. Ensure that WEP and SSID settings are accurate.</li> </ol>
<p>Unable to Play Xvid, or MPEG, or AVI video files etc.</p>	<ol style="list-style-type: none"> <li>1. Ensure that the selected video file contains supported video codec.</li> <li>2. Run the check Disk on the SETUP.</li> <li>3. If playing a file from a network drive, there may be too much traffic on the network (check for virus). Try to reboot your PC and establish connection again.</li> </ol>
<p>Time-shifting is not working in digital channel.</p>	<p>The first partition of the internal hard disk must use the NTFS format. FAT32 format can cause an error message.</p>



## 12 Appendix - Technical Terms

### HDMI

---

The High-Definition Multimedia Interface (HDMI) is an all-digital audio/video interface capable of transmitting uncompressed streams. HDMI is compatible with High-bandwidth Digital Content Protection (HDCP) Digital Rights Management technology.

HDMI provides an interface between any compatible digital audio/video source, such as a set-top box, a DVD player, a PC, a video game console, or an AV receiver and a compatible digital audio and/or video monitor, such as a digital television (DTV). In 2006, HDMI began to appear as a feature on prosumer, HDTV camcorders and even high-end digital still cameras.

### DivX

---

DivX is the name of a revolutionary new video codec which is based on the new MPEG-4 compression standard for video. When you install a video codec on your system it basically works as an add-on to your system with instructions on how to compress/decompress video in that video format. Once you've installed the DivX codec on your system you will be able to play DivX movies using Windows Media Player or any other DivX-enabled player.

Despite the fact that DivX movies offer better compression and higher quality video than regular MPEG movies it takes more time to encode due to the incredible compression technology. The DivX codec makes it possible to compress/encode a full-length movie at near DVD-quality, which is small enough to fit on a single CD (700MB). The DivX video is usually combined with MP3 audio to produce both high quality video and audio.

### Xvid

---

XviD is the name of a new open-source video codec, which like the DivX is based on the new MPEG-4 compression standard for video. It's currently being developed by people from all over the world. When you install a video codec on your system, it basically works as an 'add-on' to your system with instructions on how to compress/decompress video in that video format. Once you've installed the XviD codec on your system you will be able to play XviD movies using Windows Media Player or any other XviD-enabled player.

### MPEG

---

MPEG stands for Motion Picture Experts Group. This is the same group that made the MPEG-1 (used in VideoCDs), MPEG-2 (used in DVD and SuperVCDs and other high bandwidth systems) and MPEG-4 (ASF, DivX, WMV, low-mid bandwidth systems) standards. They are also responsible for MP3 (MPEG Audio Layer 3) and AAC audio compression standards.

### VOB

---

VOB stands for Video Objects. DVD movies are stored in VOB files. Each VOB file has a number of video/audio/subpicture streams.

### AVI

---

AVI stands for Audio Video Interleave. AVI is a file format, like MP3 or JPG. But unlike these formats, AVI is a container format, meaning it can contain video/audio compressed files using many different combinations of codecs. Therefore, while MP3 and JPG can only contain a certain kind of compression (MPEG Audio Layer 3 and JPEG), AVI can contain many different kinds of compression (eg. DivX video + WMA audio or Indeo video + PCM audio) as long as a codec is available for encoding/decoding. All AVI files look the same on the "outside", but on the "inside", they may be completely different. Almost all tools on this site are not just DivX tools, but also AVI tools, so will work with many other codecs.

### Dolby Digital

---

Initially known as Audio Coding 3, Dolby Digital is a synonym for Dolby Digital these days. Dolby Digital is an advanced audio compression technology allowing to encode up to 6 separate channels at bit-rates up to 640kbit/s. For more information please check out the Dolby website.

### DTS

By supplying film studios with outstanding techniques for delivering soundtracks to an attentive audience, DTS digital sound is now featured on virtually 100% of major Hollywood releases. Although the technology used for motion pictures differs from that featured in consumer and professional audio music and home theater systems, their DTS heritage means end users can enjoy sound that closely matches the original.

### WMA

WMA stands for Windows Media Audio. It is a proprietary format developed by Microsoft for audio streaming and compression. WMA files, theoretically, has double the compression rate of MP3s, although this is debatable.

### Ogg Vorbis

Ogg Vorbis is a new audio compression format. It is roughly comparable to other formats used to store and play digital music, such as MP3, VQF, AAC, and other digital audio formats. It is different from these other formats because it is completely free, open, and unpatented.

Ogg Vorbis has been designed to completely replace all proprietary, patented audio formats. That means that you can encode all your music or audio content in Vorbis and never look back.

### 480P

480 progressive; form of standard-definition digital television (SDTV) comparable to VGA computer displays but not considered high-definition television (HDTV), though 480p is discernibly cleaner and slightly sharper than analog television. The native resolution of DVD is 480p, but that resolution can be seen only if a DVD player outputs a progressive-scan signal and the DTV has progressive-scan or component-video inputs; it is also known as EDTV.

### 720P

720 progressive. One of two currently used formats designated as high-definition television in the ATSC DTV standard, this technology comprises 720 vertical pixels and 1,280 horizontal pixels. The p stands for progressive, as opposed to interlaced, scanning, which is used in the other accepted HDTV standard, known as 1080i. Contrary to myth, 720p is not inferior to 1080i; 720p has fewer lines but also has the advantages of progressive scanning and a constant vertical resolution of 720 lines, making it better able to handle motion.

### 1080i

1080 interlaced; one of two formats designated as high-definition television in the ATSC DTV standard, with 1,080 vertical pixels by 1,920 horizontal pixels. The i stands for interlaced, as opposed to progressive scanning, used in the second HDTV standard, 720p. Contrary to myth, 1080i is not superior to 720p; 1080i has more scanning lines but also suffers the disadvantages of interlaced scanning.

### NTSC

The NTSC (National Television Standards Committee) was responsible for developing, in 1953, a set of standard protocol for television (TV) broadcast transmission and reception in the United States. Two other standards - Phase Alternation Line (PAL) and Sequential Couleur avec Memoire (SECAM) - are used in other parts of the world. The NTSC standards have not changed significantly since their inception, except for the addition of new parameters for color signals. NTSC signals are not directly compatible with computer systems. An NTSC TV image has 525 horizontal lines per frame (complete screen image). These lines are scanned from left to right and from top to bottom. Every other line is skipped. Thus it takes two screen scans to complete a frame: one scan for the odd-numbered horizontal lines, and another scan for the even-numbered lines. Each half-frame screen scan takes approximately 1/60 of a second; a complete frame is scanned every 1/30 second. This alternate-line scanning system is known as interlacing.

### PAL

Phase Alternation Line (PAL) is the analog television display standard that is used in Europe and certain other parts of the world. PAL is one of the three major TV standards together with the American National Television Systems Committee(NTSC) color television system and the French Sequential Couleur avec Memoire (SECAM). NTSC is also used in Japan. SECAM is used in countries of the former Soviet Union. Like SECAM, PAL scans the cathode ray tube (CRT) horizontally 625 times to form the video image. NTSC scans 525 lines. Color definitions between the systems vary slightly.

## 13 GNU General Public License

DVICO Co., Ltd is using a part of Free Software code under the GNU General Public License in operating TVX-HD player. This General Public License applies to most of the Free Software Foundation's code and to any other program whose authors commit by using it. The Free Software is copyrighted by Free Software Foundation, Inc. and the program is licensed "As is" without warranty of any kind. Users are free to download the base source code of the dvico TVX-HD players at the following Address: [www.TViX.co.kr/gpl](http://www.TViX.co.kr/gpl) The source code can be sent to your address via airmail for a charge of actual expense executed. Please contact us at [sales@dvico.com](mailto:sales@dvico.com)

### GNU GENERAL PUBLIC LICENSE

Version 2, June 1991

Copyright (C) 1989, 1991 Free Software Foundation, Inc.  
51 Franklin Street, Fifth Floor, Boston, MA 02110-1301, USA

Everyone is permitted to copy and distribute verbatim copies of this license document, but changing it is not allowed.

#### Preamble

The licenses for most software are designed to take away your freedom to share and change it. By contrast, the GNU General Public License is intended to guarantee your freedom to share and change free software--to make sure the software is free for all its users. This General Public License applies to most of the Free Software Foundation's software and to any other program whose authors commit to using it. (Some other Free Software Foundation software is covered by the GNU Lesser General Public License instead.) You can apply it to your programs, too.

When we speak of free software, we are referring to freedom, not price. Our General Public Licenses are designed to make sure that you have the freedom to distribute copies of free software (and charge for this service if you wish), that you receive source code or can get it if you want it, that you can change the software or use pieces of it in new free programs; and that you know you can do these things.

To protect your rights, we need to make restrictions that forbid anyone to deny you these rights or to ask you to surrender the rights. These restrictions translate to certain responsibilities for you if you distribute copies of the software, or if you modify it.

For example, if you distribute copies of such a program, whether gratis or for a fee, you must give the recipients all the rights that you have. You must make sure that they, too, receive or can get the source code. And you must show them these terms so they know their rights.

We protect your rights with two steps: (1) copyright the software, and (2) offer you this license which gives you legal permission to copy, distribute and/or modify the software.

Also, for each author's protection and ours, we want to make certain that everyone understands that there is no warranty for this free software. If the software is modified by someone else and passed on, we want its recipients to know that what they have is not the original, so that any problems introduced by others will not reflect on the original authors' reputations.

Finally, any free program is threatened constantly by software patents. We wish to avoid the danger that redistributors of a free program will individually obtain patent licenses, in effect making the program proprietary. To prevent this, we have made it clear that any patent must be licensed for everyone's free use or not licensed at all.

The precise terms and conditions for copying, distribution and modification follow.

#### TERMS AND CONDITIONS FOR COPYING, DISTRIBUTION AND MODIFICATION

0. This License applies to any program or other work which contains a notice placed by the copyright holder saying it may be distributed under the terms of this General Public License. The "Program", below, refers to any such program or work, and a "work based on the Program" means either the Program or any derivative work under copyright law: that is to say, a work containing the Program or a portion of it, either verbatim or with modifications and/or translated into another language. (Hereinafter, translation is included without limitation in the term "modification".) Each licensee is addressed as "you".

Activities other than copying, distribution and modification are not covered by this License; they are outside its scope. The act of running the Program is not restricted, and the output from the Program is covered only if its contents constitute a work based on the Program (independent of having been made by running the Program). Whether that is true depends on what the Program does.

1. You may copy and distribute verbatim copies of the Program's source code as you receive it, in any medium, provided that you conspicuously and appropriately publish on each copy an appropriate copyright notice and disclaimer of warranty; keep intact all the notices that refer to this License and to the absence of any warranty; and give any other recipients of the Program a copy of this License along with the Program.

You may charge a fee for the physical act of transferring a copy, and you may at your option offer warranty

protection in exchange for a fee.

2. You may modify your copy or copies of the Program or any portion of it, thus forming a work based on the Program, and copy and distribute such modifications or work under the terms of Section 1 above, provided that you also meet all of these conditions:

a) You must cause the modified files to carry prominent notices stating that you changed the files and the date of any change.

b) You must cause any work that you distribute or publish, that in whole or in part contains or is derived from the Program or any part thereof, to be licensed as a whole at no charge to all third parties under the terms of this License.

c) If the modified program normally reads commands interactively when run, you must cause it, when started running for such interactive use in the most ordinary way, to print or display an announcement including an appropriate copyright notice and a notice that there is no warranty (or else, saying that you provide a warranty) and that users may redistribute the program under these conditions, and telling the user how to view a copy of this License. (Exception: if the Program itself is interactive but does not normally print such an announcement, your work based on the Program is not required to print an announcement.)

These requirements apply to the modified work as a whole. If identifiable sections of that work are not derived from the Program, and can be reasonably considered independent and separate works in themselves, then this License, and its terms, do not apply to those sections when you distribute them as separate works. But when you distribute the same sections as part of a whole which is a work based on the Program, the distribution of the whole must be on the terms of this License, whose permissions for other licensees extend to the entire whole, and thus to each and every part regardless of who wrote it.

Thus, it is not the intent of this section to claim rights or contest your rights to work written entirely by you; rather, the intent is to exercise the right to control the distribution of derivative or collective works based on the Program.

In addition, mere aggregation of another work not based on the Program with the Program (or with a work based on the Program) on a volume of a storage or distribution medium does not bring the other work under the scope of this License.

3. You may copy and distribute the Program (or a work based on it, under Section 2) in object code or executable form under the terms of Sections 1 and 2 above provided that you also do one of the following:

a) Accompany it with the complete corresponding machine-readable source code, which must be distributed under the terms of Sections 1 and 2 above on a medium customarily used for software interchange; or,

b) Accompany it with a written offer, valid for at least three years, to give any third party, for a charge no more than your cost of physically performing source distribution, a complete machine-readable copy of the corresponding source code, to be distributed under the terms of Sections 1 and 2 above on a medium customarily used for software interchange; or,

c) Accompany it with the information you received as to the offer to distribute corresponding source code. (This alternative is allowed only for noncommercial distribution and only if you received the program in object code or executable form with such an offer, in accord with Subsection b above.)

The source code for a work means the preferred form of the work for making modifications to it. For an executable work, complete source code means all the source code for all modules it contains, plus any associated interface definition files, plus the scripts used to control compilation and installation of the executable. However, as a special exception, the source code distributed need not include anything that is normally distributed (in either source or binary form) with the major components (compiler, kernel, and so on) of the operating system on which the executable runs, unless that component itself accompanies the executable.

If distribution of executable or object code is made by offering access to copy from a designated place, then offering equivalent access to copy the source code from the same place counts as distribution of the source code, even though third parties are not compelled to copy the source along with the object code.

4. You may not copy, modify, sublicense, or distribute the Program except as expressly provided under this License. Any attempt otherwise to copy, modify, sublicense or distribute the Program is void, and will automatically terminate your rights under this License. However, parties who have received copies, or rights, from you under this License will not have their licenses terminated so long as such parties remain in full compliance.

5. You are not required to accept this License, since you have not signed it. However, nothing else grants you permission to modify or distribute the Program or its derivative works. These actions are prohibited by law if you do not accept this License. Therefore, by modifying or distributing the Program (or any work based on the Program), you indicate your acceptance of this License to do so, and all its terms and conditions for copying, distributing or modifying the Program or works based on it.

6. Each time you redistribute the Program (or any work based on the Program), the recipient automatically receives a license from the original licensor to copy, distribute or modify the Program subject to these terms and conditions. You may not impose any further restrictions on the recipients' exercise of the rights granted herein. You are not responsible for enforcing compliance by third parties to this License.

7. If, as a consequence of a court judgment or allegation of patent infringement or for any other reason (not limited to patent issues), conditions are imposed on you (whether by court order, agreement or otherwise) that contradict the conditions of this License, they do not excuse you from the conditions of this License. If you cannot distribute so as to satisfy simultaneously your obligations under this License and any other pertinent obligations, then as a consequence you may not distribute the Program at all. For example, if a patent license would not permit royalty-free redistribution of the Program by all those who receive copies directly or indirectly through you, then the only way you could satisfy both it and this License would be to refrain entirely from distribution of the Program.

If any portion of this section is held invalid or unenforceable under any particular circumstance, the balance of the section is intended to apply and the section as a whole is intended to apply in other circumstances.

It is not the purpose of this section to induce you to infringe any patents or other property right claims or to contest validity of any such claims; this section has the sole purpose of protecting the integrity of the free software distribution system, which is implemented by public license practices. Many people have made generous contributions to the wide range of software distributed through that system in reliance on consistent application of that system; it is up to the author/donor to decide if he or she is willing to distribute software through any other system and a licensee cannot impose that choice.

This section is intended to make thoroughly clear what is believed to be a consequence of the rest of this License.

8. If the distribution and/or use of the Program is restricted in certain countries either by patents or by copyrighted interfaces, the original copyright holder who places the Program under this License may add an explicit geographical distribution limitation excluding those countries, so that distribution is permitted only in or among countries not thus excluded. In such case, this License incorporates the limitation as if written in the body of this License.

9. The Free Software Foundation may publish revised and/or new versions of the General Public License from time to time. Such new versions will be similar in spirit to the present version, but may differ in detail to address new problems or concerns.

Each version is given a distinguishing version number. If the Program specifies a version number of this License which applies to it and "any later version", you have the option of following the terms and conditions either of that version or of any later version published by the Free Software Foundation. If the Program does not specify a version number of this License, you may choose any version ever published by the Free Software Foundation.

10. If you wish to incorporate parts of the Program into other free programs whose distribution conditions are different, write to the author to ask for permission. For software which is copyrighted by the Free Software Foundation, write to the Free Software Foundation; we sometimes make exceptions for this. Our decision will be guided by the two goals of preserving the free status of all derivatives of our free software and of promoting the sharing and reuse of software generally.

**NO WARRANTY**

11. BECAUSE THE PROGRAM IS LICENSED FREE OF CHARGE, THERE IS NO WARRANTY FOR THE PROGRAM, TO THE EXTENT PERMITTED BY APPLICABLE LAW. EXCEPT WHEN OTHERWISE STATED IN WRITING THE COPYRIGHT HOLDERS AND/OR OTHER PARTIES PROVIDE THE PROGRAM "AS IS" WITHOUT WARRANTY OF ANY KIND, EITHER EXPRESSED OR IMPLIED, INCLUDING, BUT NOT LIMITED TO, THE IMPLIED WARRANTIES OF MERCHANTABILITY AND FITNESS FOR A PARTICULAR PURPOSE. THE ENTIRE RISK AS TO THE QUALITY AND PERFORMANCE OF THE PROGRAM IS WITH YOU. SHOULD THE PROGRAM PROVE DEFECTIVE, YOU ASSUME THE COST OF ALL NECESSARY SERVICING, REPAIR OR CORRECTION.

12. IN NO EVENT UNLESS REQUIRED BY APPLICABLE LAW OR AGREED TO IN WRITING WILL ANY COPYRIGHT HOLDER, OR ANY OTHER PARTY WHO MAY MODIFY AND/OR REDISTRIBUTE THE PROGRAM AS PERMITTED ABOVE, BE LIABLE TO YOU FOR DAMAGES, INCLUDING ANY GENERAL, SPECIAL, INCIDENTAL OR CONSEQUENTIAL DAMAGES ARISING OUT OF THE USE OR INABILITY TO USE THE PROGRAM (INCLUDING BUT NOT LIMITED TO LOSS OF DATA OR DATA BEING RENDERED INACCURATE OR LOSSES SUSTAINED BY YOU OR THIRD PARTIES OR A FAILURE OF THE PROGRAM TO OPERATE WITH ANY OTHER PROGRAMS), EVEN IF SUCH HOLDER OR OTHER PARTY HAS BEEN ADVISED OF THE POSSIBILITY OF SUCH DAMAGES.